

CREA

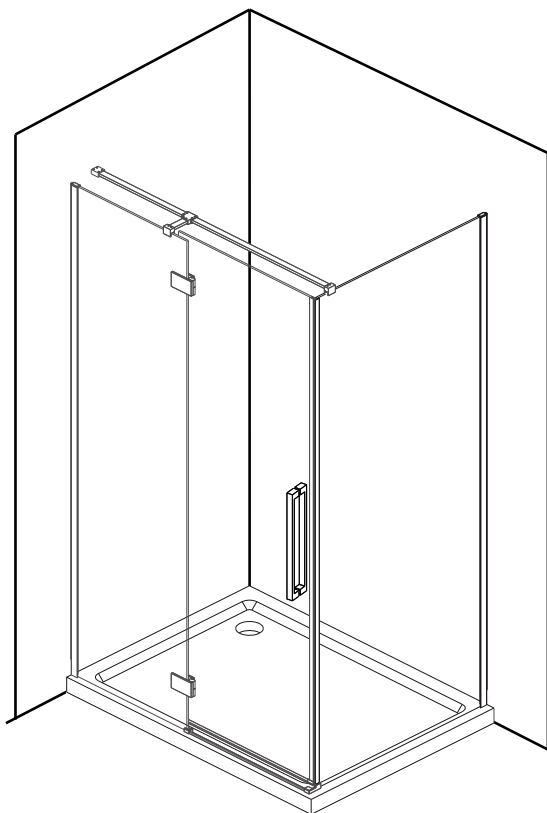

PL INSTRUKCJA MONTAŻU I EKSPLOATACJI

CZ NÁVOD NA MONTÁŽ A ÚDRŽBU

SK NÁVOD NA MONTÁŽ A ÚDRŽBU

EST PAIGALDUS- JA KASUTUSJUHEND

LT MONTAVIMO IR EKSPLOATAVIMO INSTRUKCIJA

LV MONTĀŽAS UN EKSPLUATĀCIJAS INSTRUKCIJA

DE MONTAGE- UND AUFBAUANLEITUNG

RO INSTRUCȚIUNI DE MONTAJ ȘI OPERARE

HU SZERELÉSI ÉS ÜZEMELTETÉSI ÚTMUTATÓ

UA ІНСТРУКЦІЯ З МОНТАЖУ І ЕКСПЛУАТАЦІЇ

BY ІНСТРУКЦЫЯ ПА МАНТАЖЫ І ЭКСПЛУАТАЦЫІ

RU ИНСТРУКЦИЯ ПО МОНТАЖУ И ЭКСПЛУАТАЦИИ

EN INSTRUCTIONS FOR ASSEMBLY AND USE

FR INSTALLATION ET UTILISATION - MODE

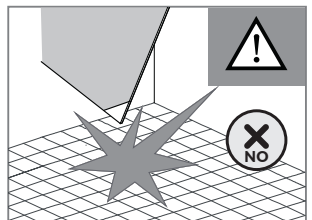
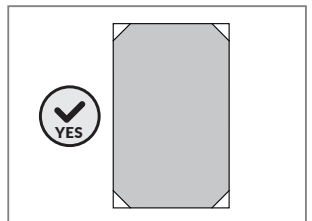
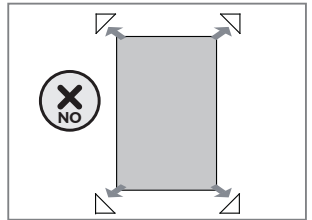
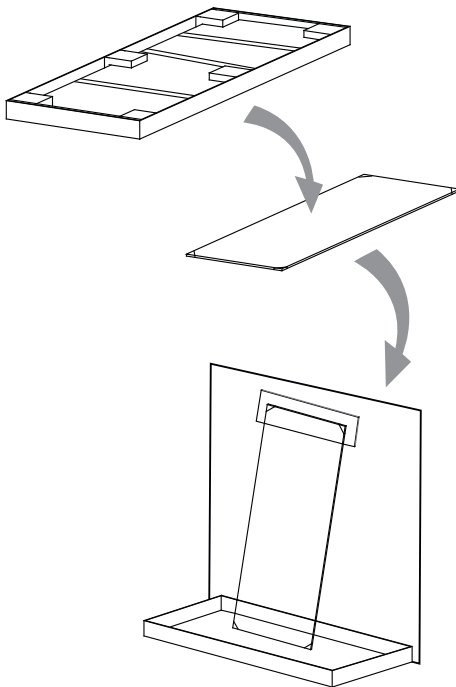
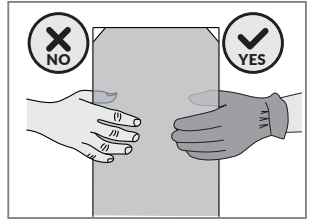
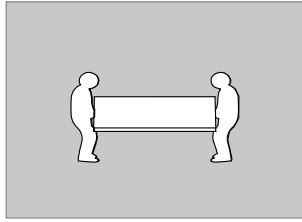
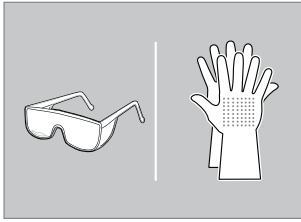
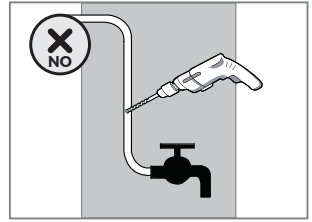
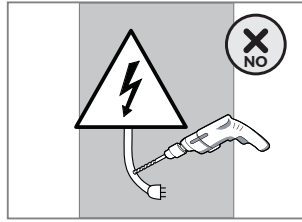
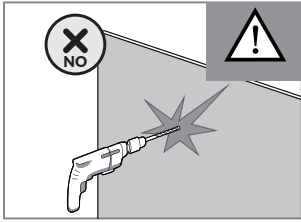

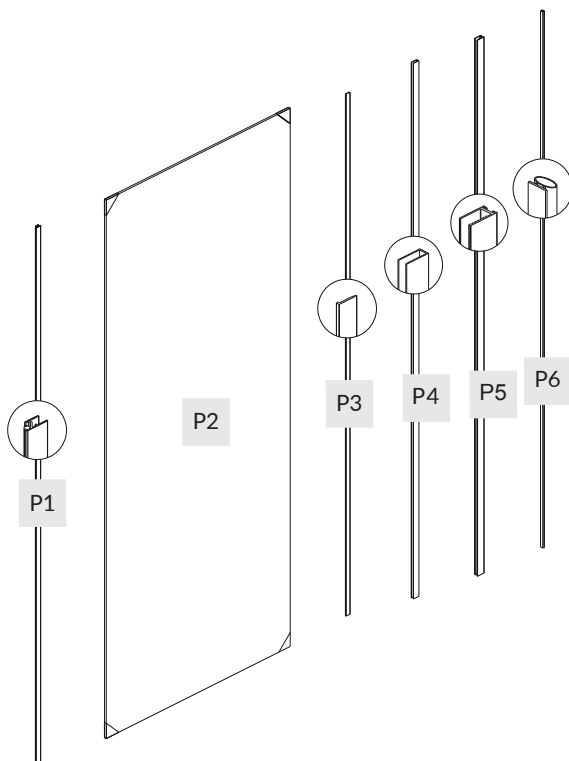
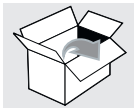

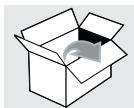

L1



x1

L2



x1

J



x1

D



x1

F1



1mm

x4

F2



2mm

x4

F3



3mm

x4

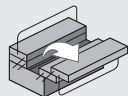

PH2

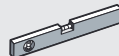

Ø 6mm

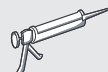
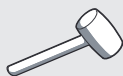

Ø 3mm

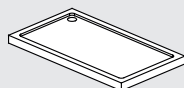

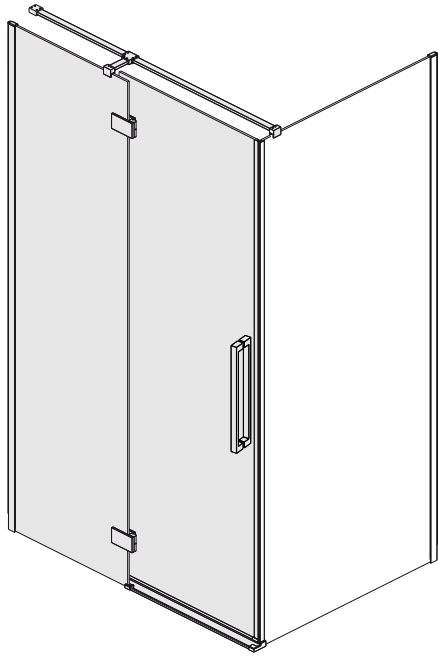
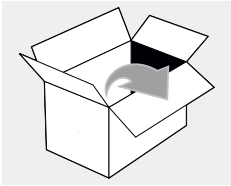

A



4X35

x8

B



x8

I1



x1

I2



x1

J



x1

K1



x1

K2



x1

L



x1

M

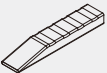

x1

F1



1mm

x4

F2



2mm

x4

F3



3mm

x4

N



2mm

x1

1.

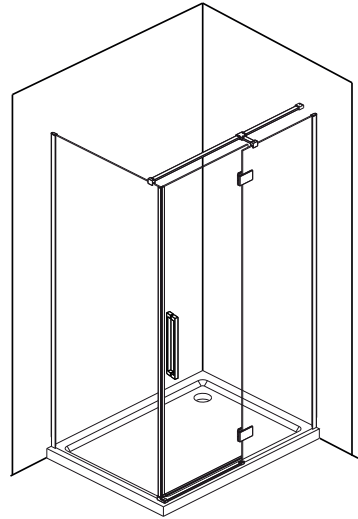
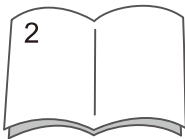
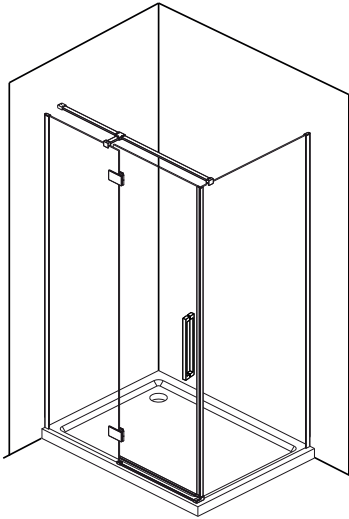

2.

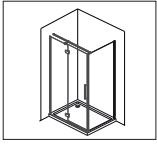

SIZE	X(mm)	Y(mm)
800X900X2000	790-800	885-895
800X1000X2000	790-800	985-995
800X1200X2000	790-800	1185-1195
900X900X2000	890-900	885-895
900X1000X2000	890-900	985-995
900X1200X2000	890-900	1185-1195

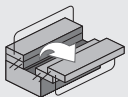
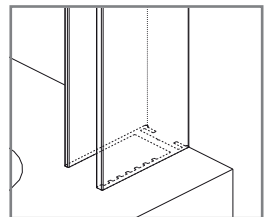
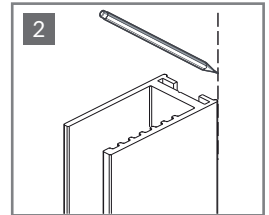
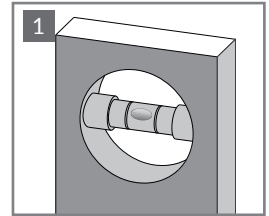
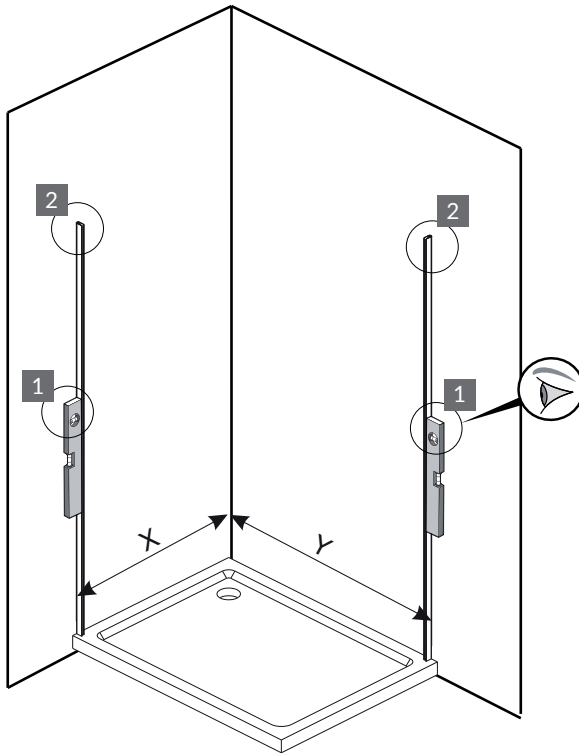

P5

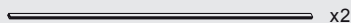

3.

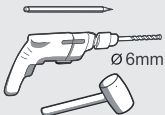
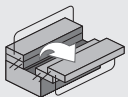
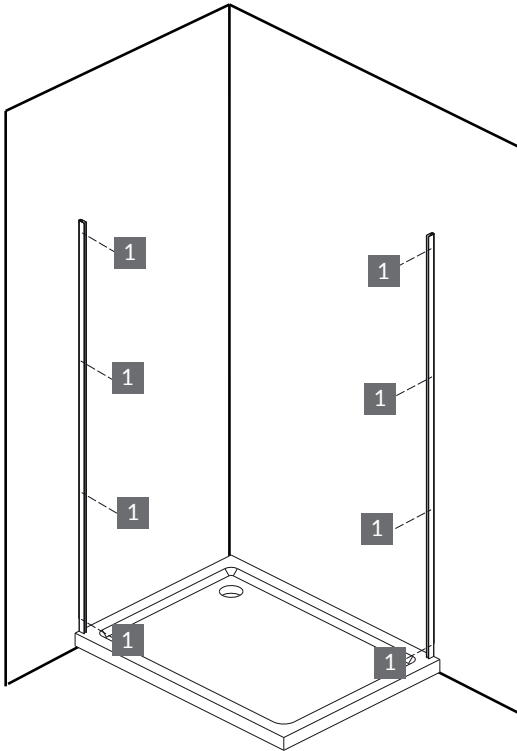
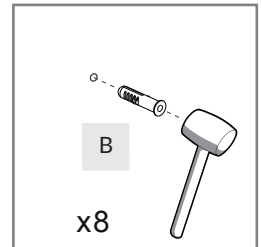
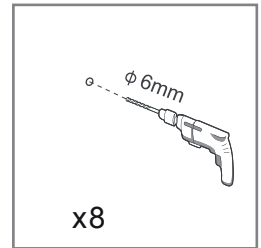
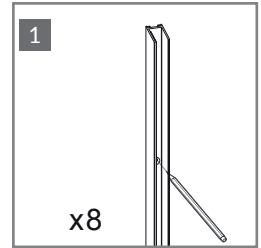
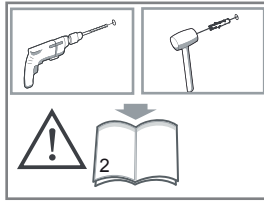
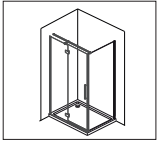

B



x8



4.

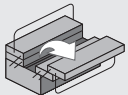
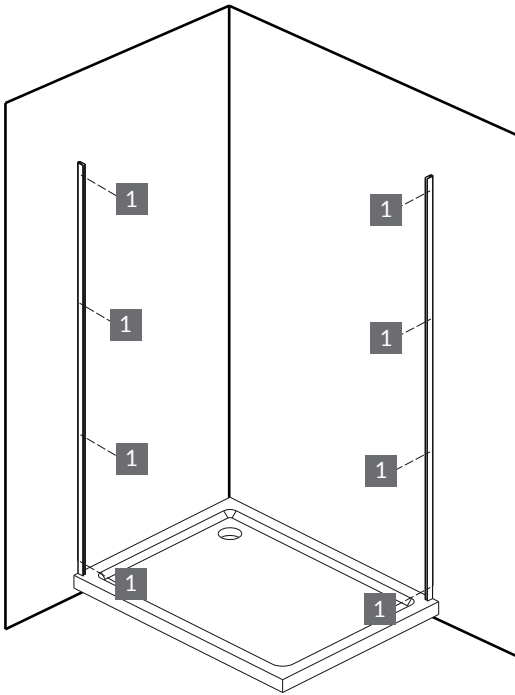
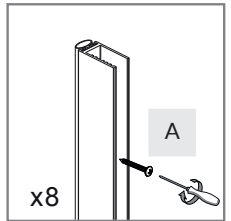
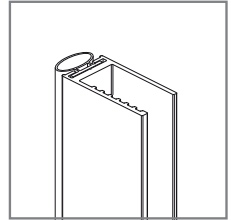
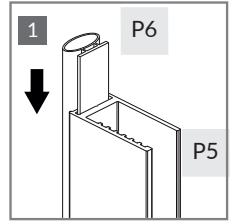
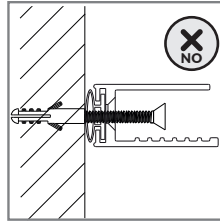
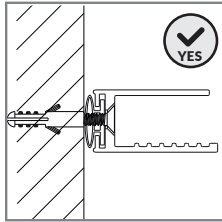
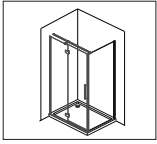

P6 ————— x2

P5 ————— x2

A  x8
4X35



5.

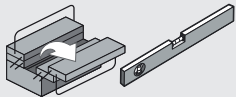
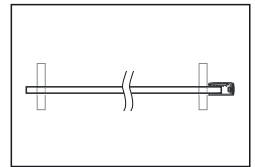
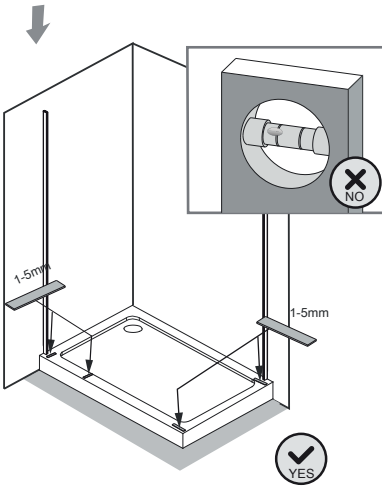
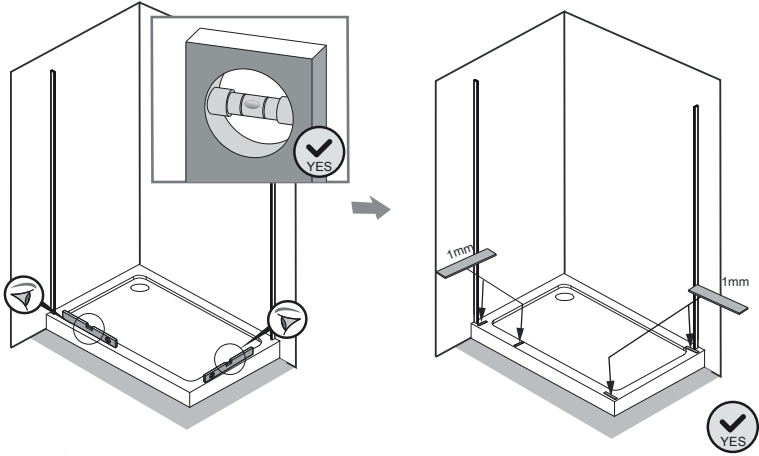
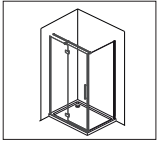

F1



x4

F2



x4

F3



x4



6.

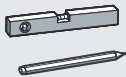
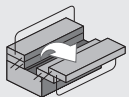
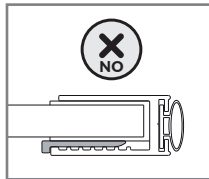
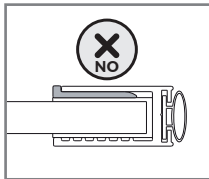
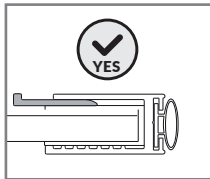
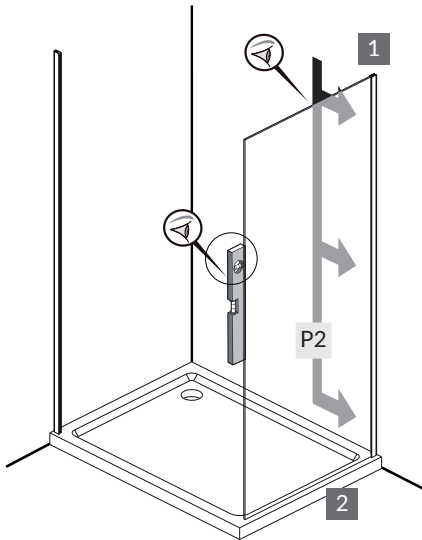
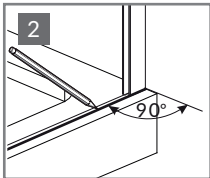
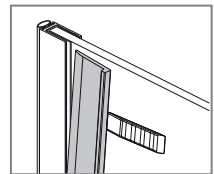
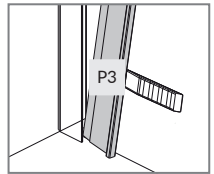
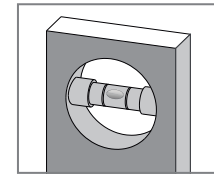
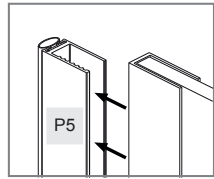
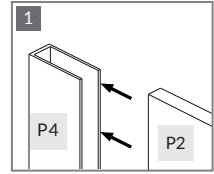
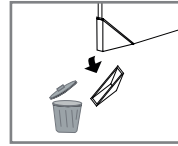
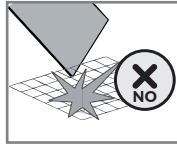
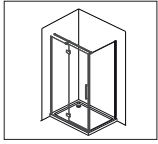

P4 ————— x1

P3 ————— x1

M ————— x1



7.

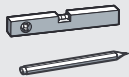
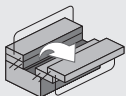
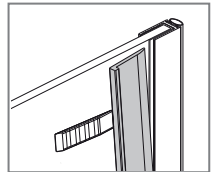
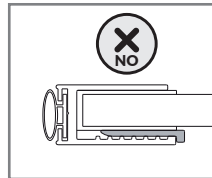
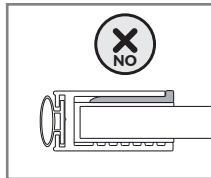
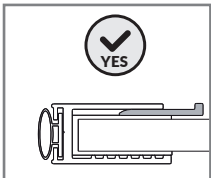
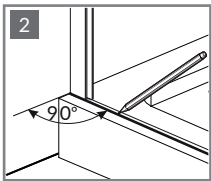
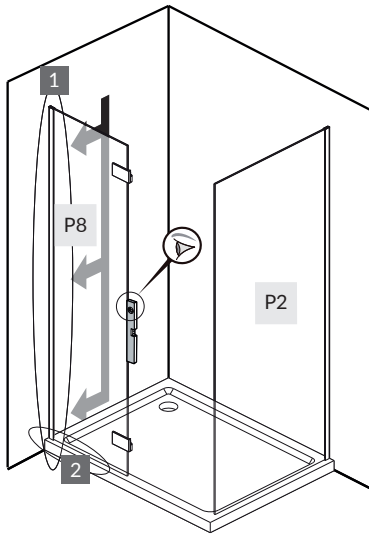
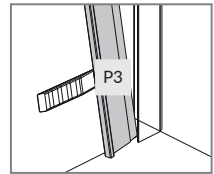
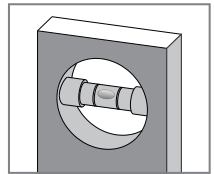
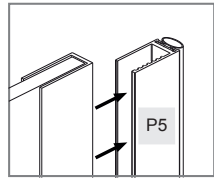
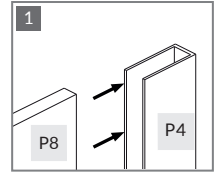
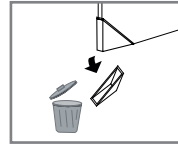
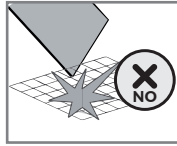
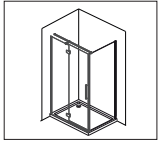

- P4 ————— x1
- P3 ————— x1
- M ————— x1



8.

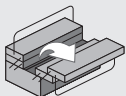
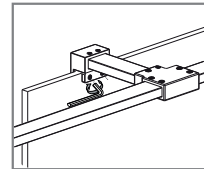
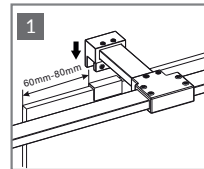
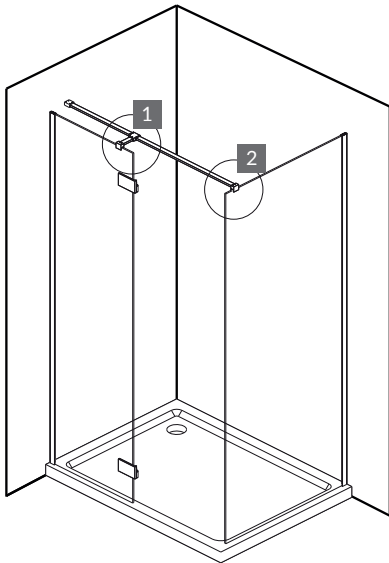
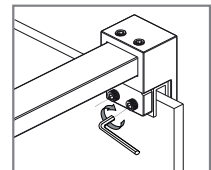
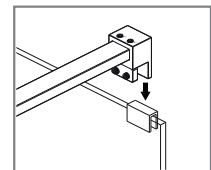
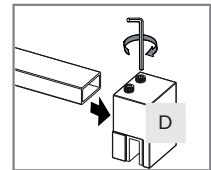
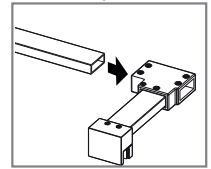
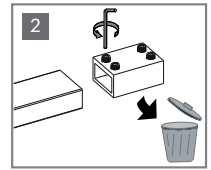
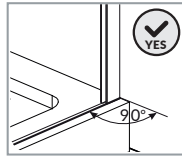
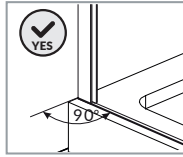
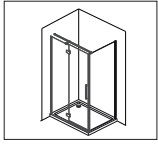

P9  x1

 x4
4X35

 x4

 x1
3mm

 x1
2.5mm

P10  x1

D  x1



9.

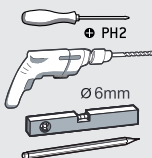
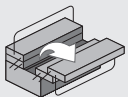
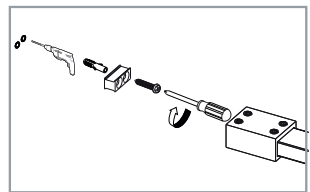
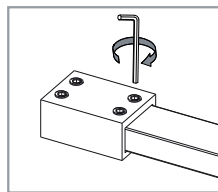
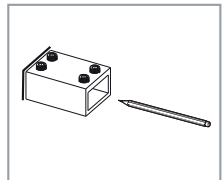
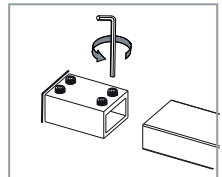
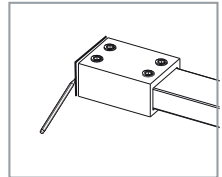
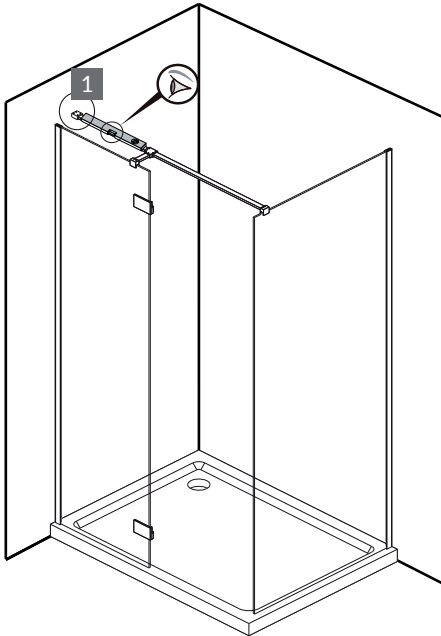
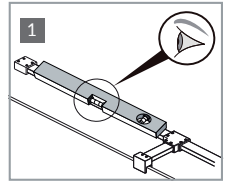
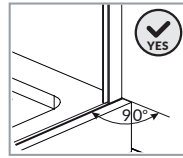
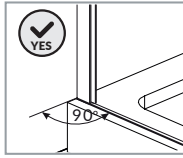
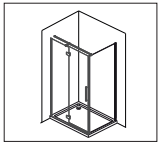

- P9  x1
- 4X35  x4
-  x4
-  3mm x1
-  2.5mm x1



10.

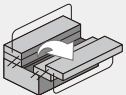
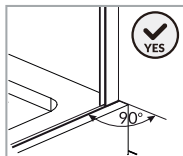
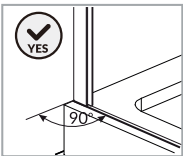
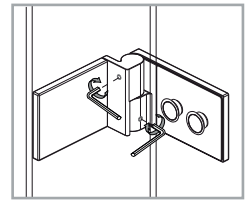
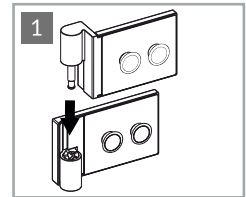
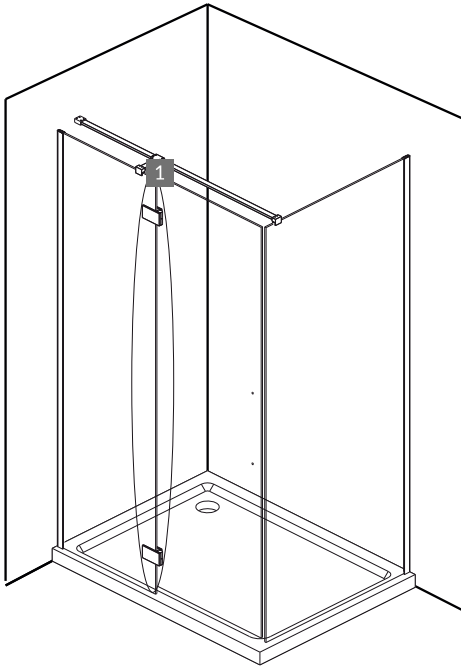
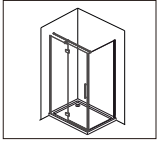

N  x1



11.

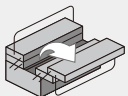
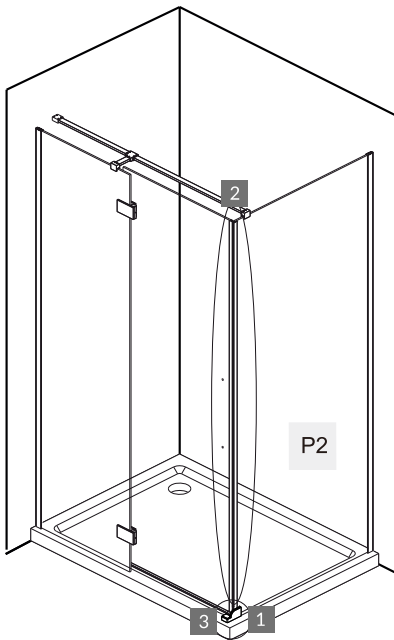
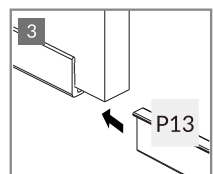
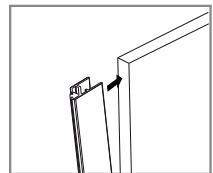
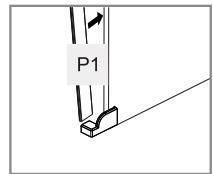
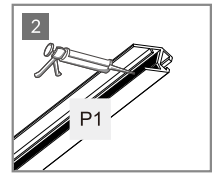
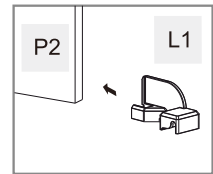
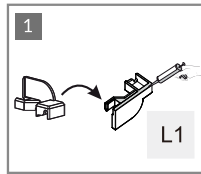
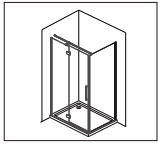

P1 ————— x1

P13 ————— x1

L1  x1



12.

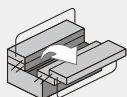
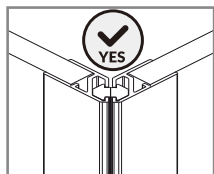
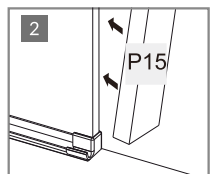
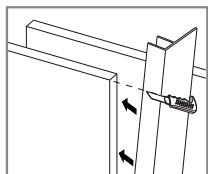
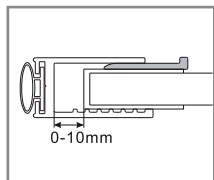
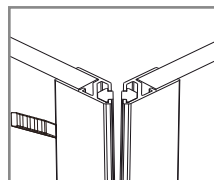
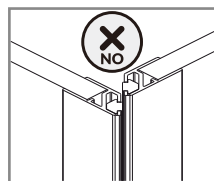
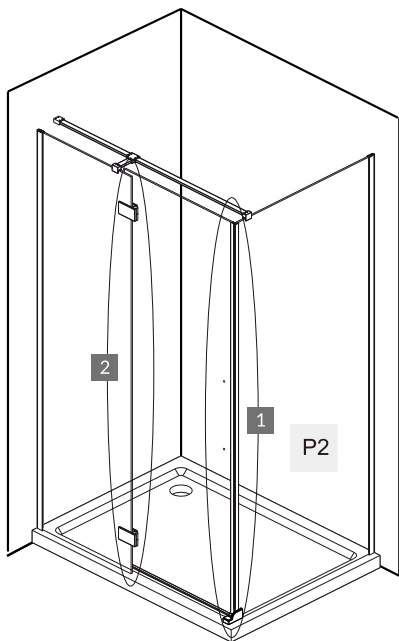
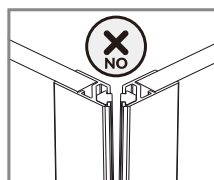
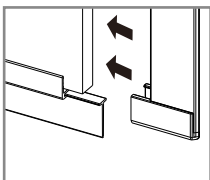
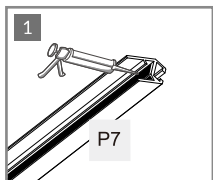
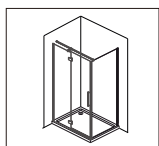

- P7 x1
- P15 x1
- M x1



13.

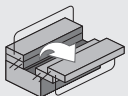
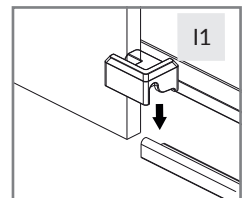
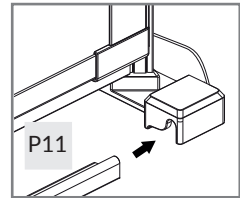
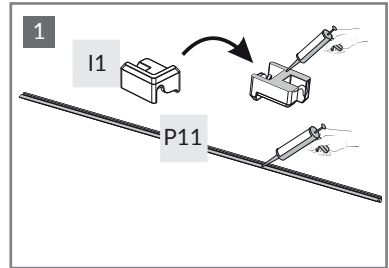
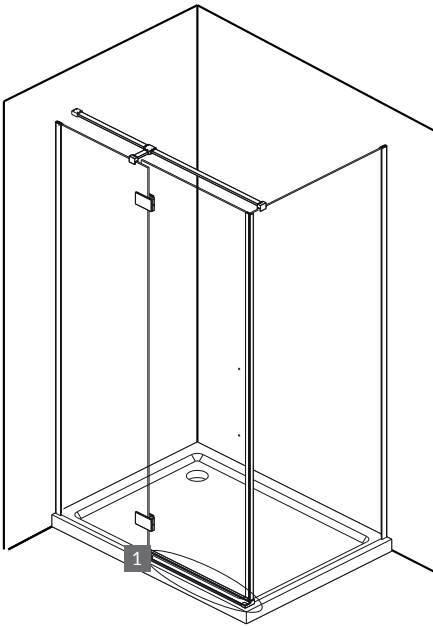
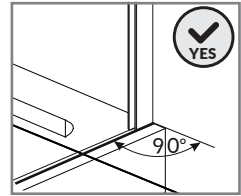
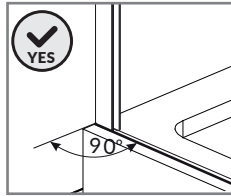
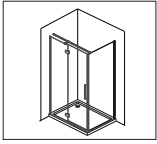

l1



x1

L1



x1

P11

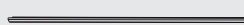

x1



14.

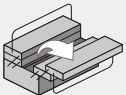
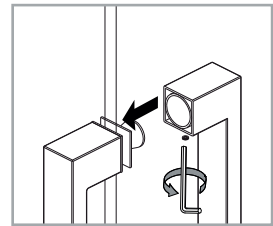
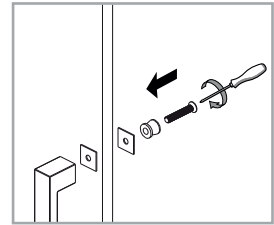
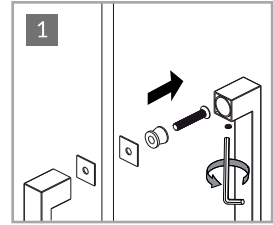
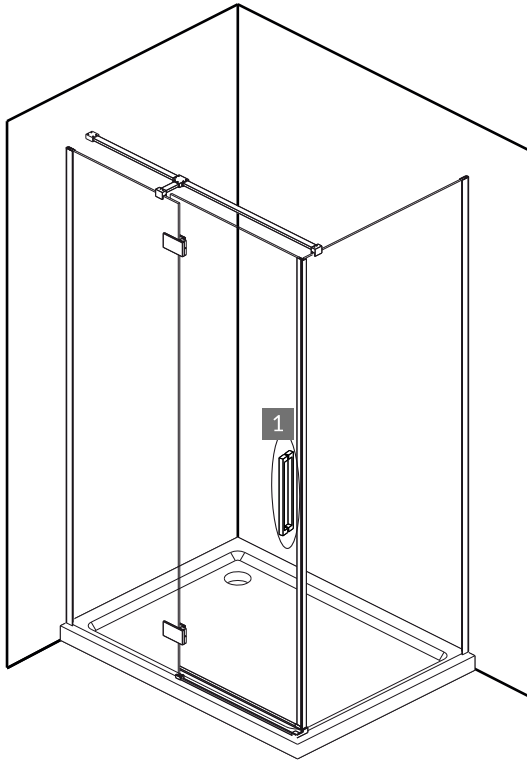
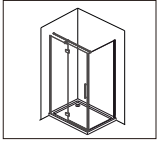

P14



x1



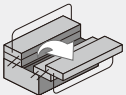
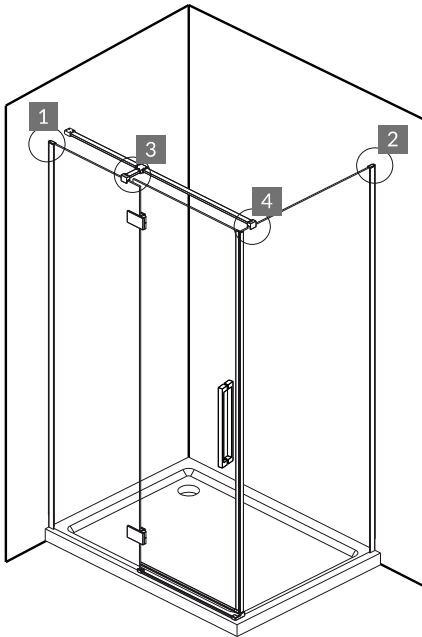
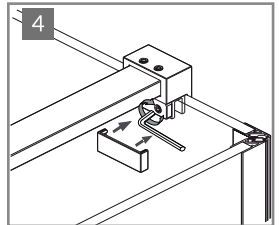
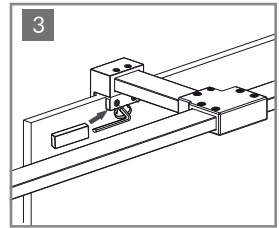
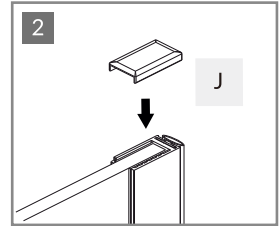
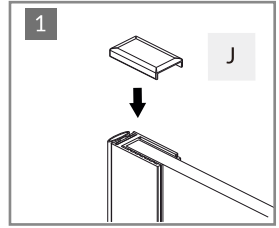
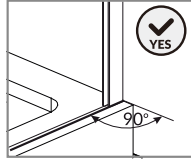
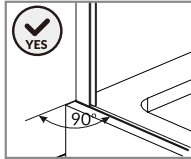
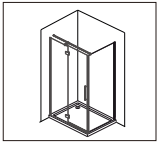

J



x2



16.

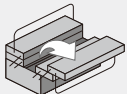
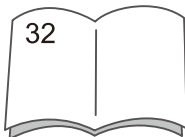
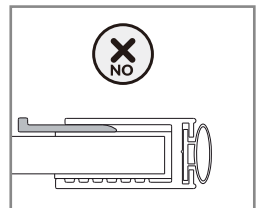
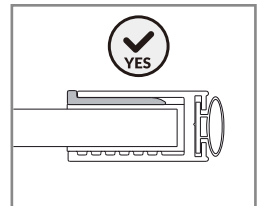
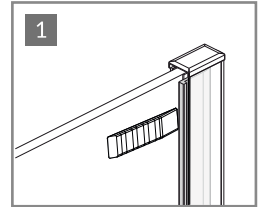
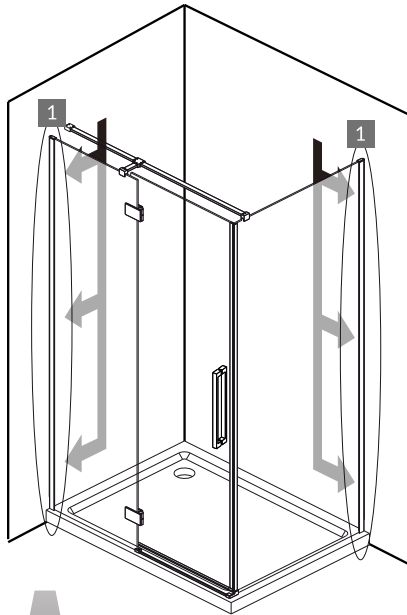
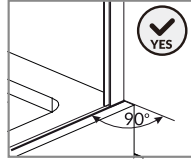
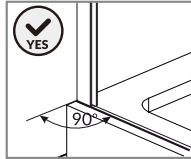
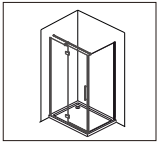

M



x1





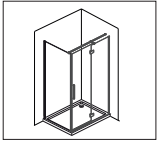

17.

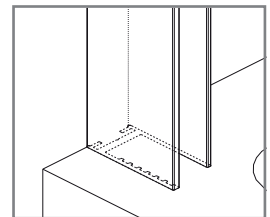
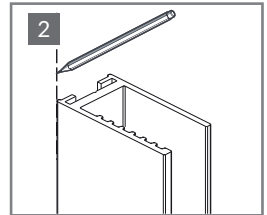
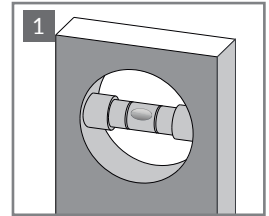
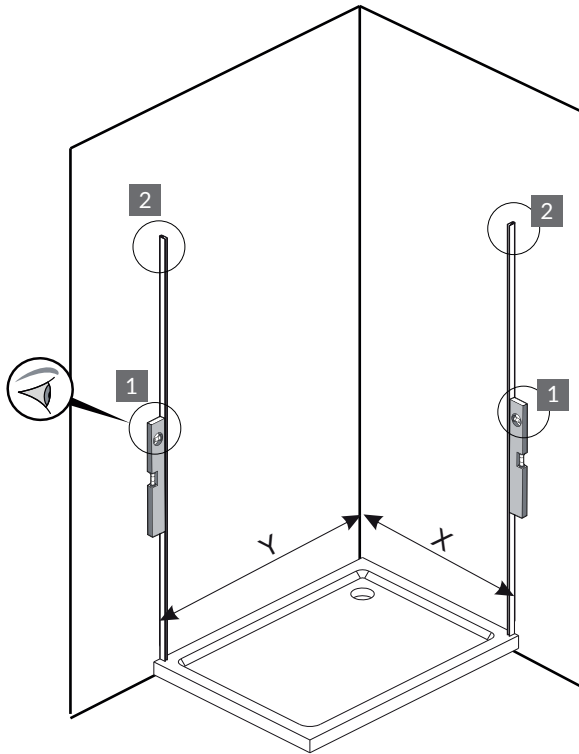

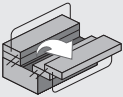
SIZE	X(mm)	Y(mm)
800X900X2000	790-800	885-895
800X1000X2000	790-800	985-995
800X1200X2000	790-800	1185-1195
900X900X2000	890-900	885-895
900X1000X2000	890-900	985-995
900X1200X2000	890-900	1185-1195



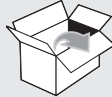

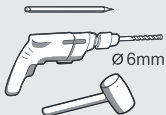
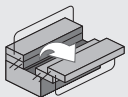
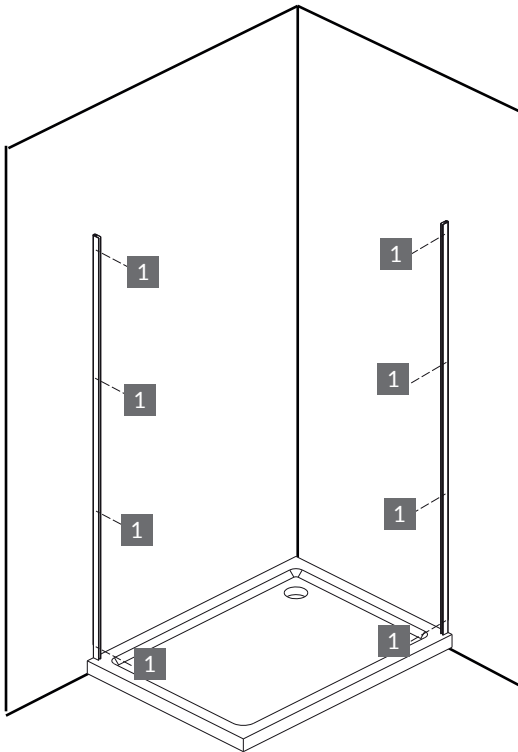
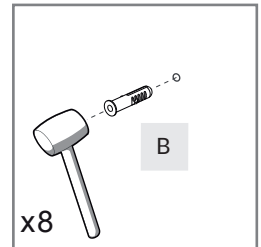
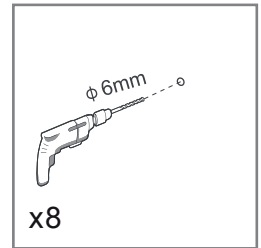
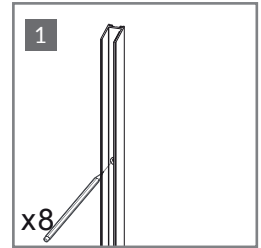
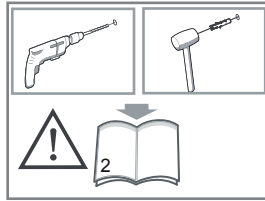
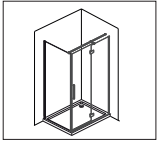

P5

x2

18.



B



x8



19.

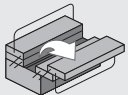
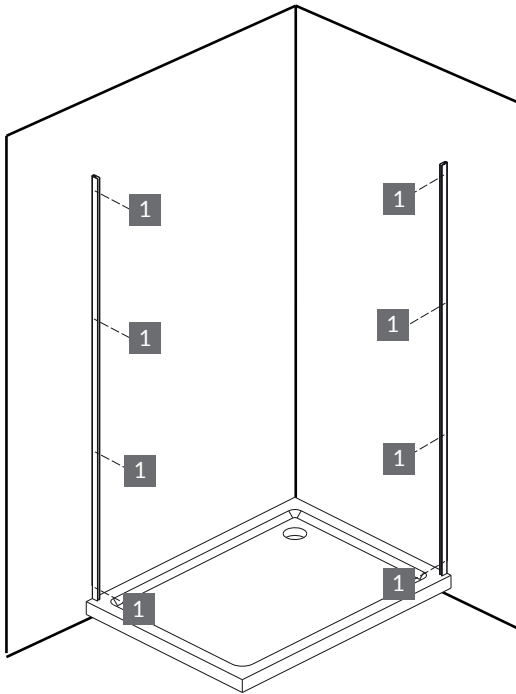
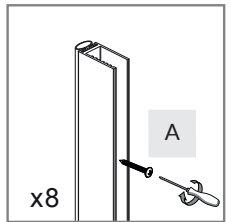
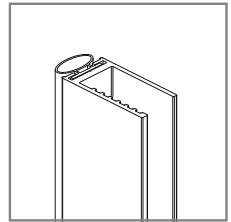
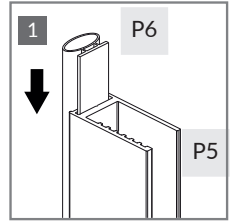
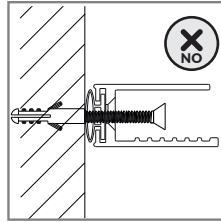
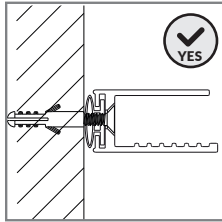
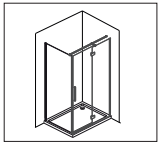

P6 ————— x2

P5 ————— x2

A  x8
4X35



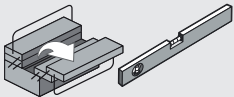
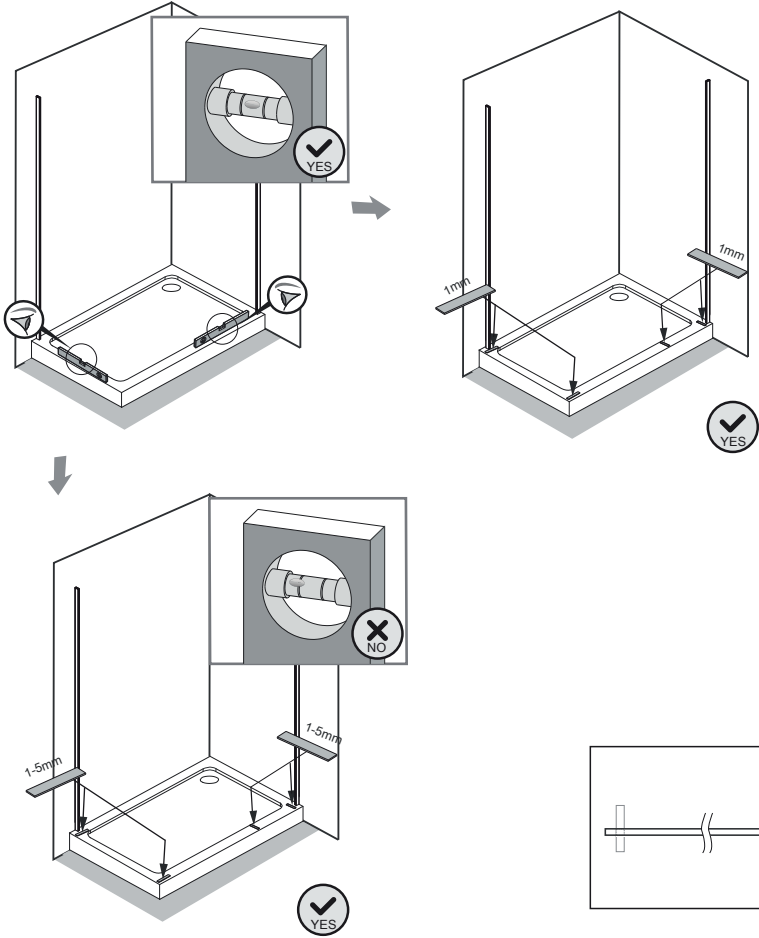
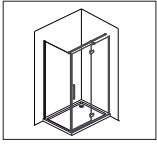

F1



x4

F2



x4

F3



x4



21.

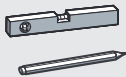
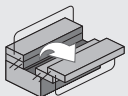
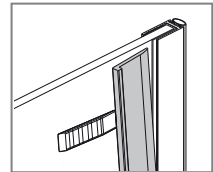
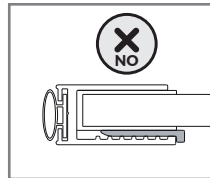
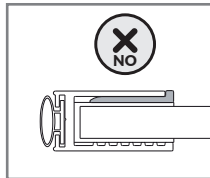
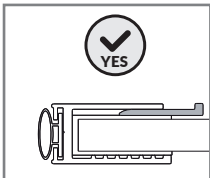
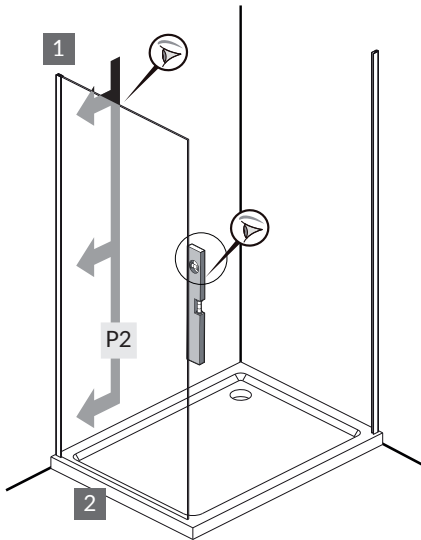
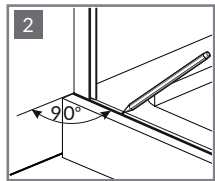
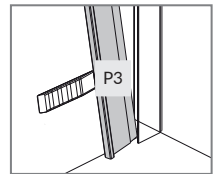
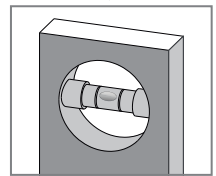
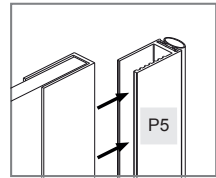
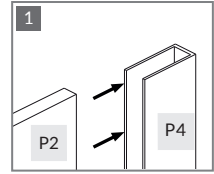
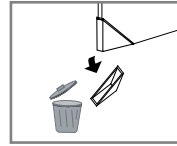
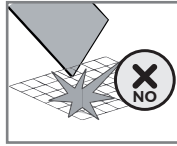
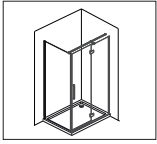

P4 ————— x1

P3 ————— x1

M ————— x1



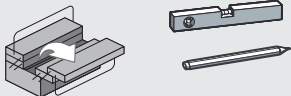
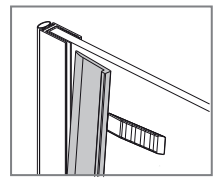
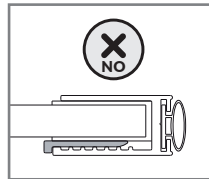
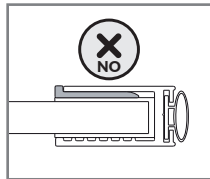
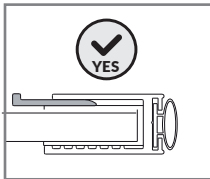
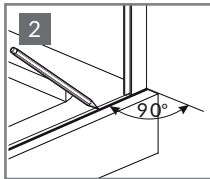
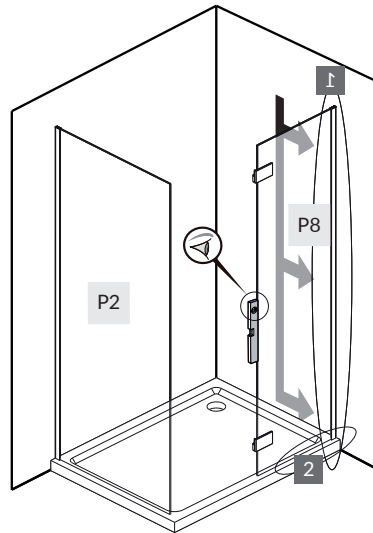
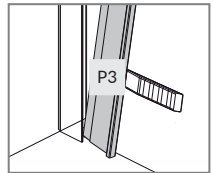
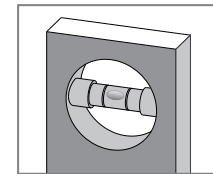
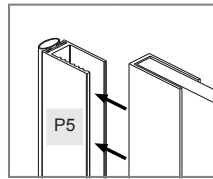
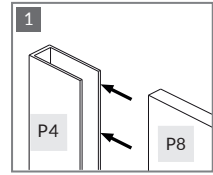
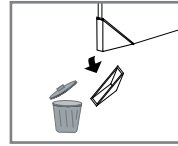
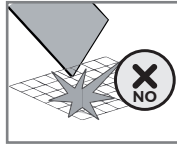
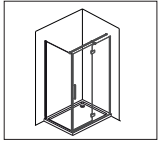

- P4 ————— x1
- P3 ————— x1
- M ————— x1



23.

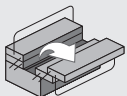
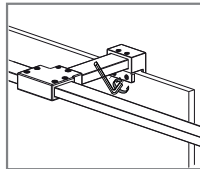
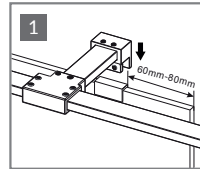
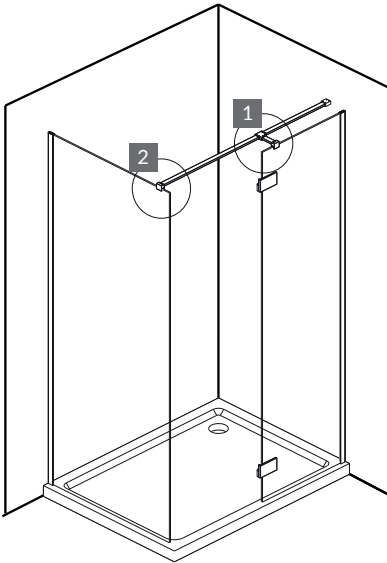
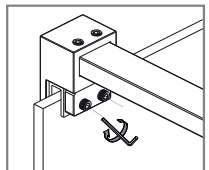
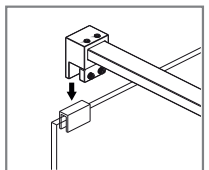
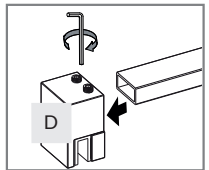
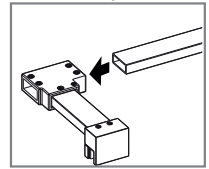
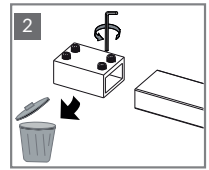
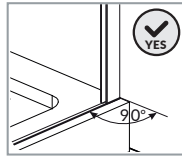
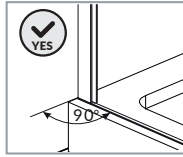
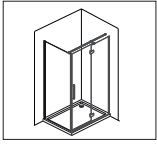

P9  x1

 x4

 x4

 x1

 x1

P10  x1

D  x1



24.

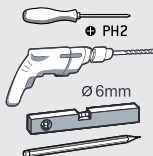
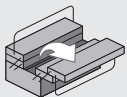
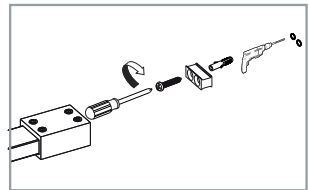
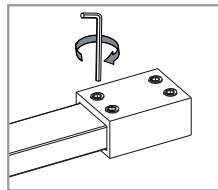
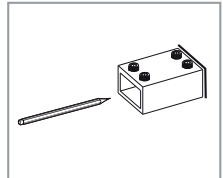
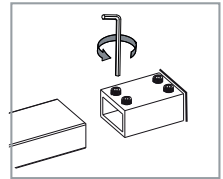
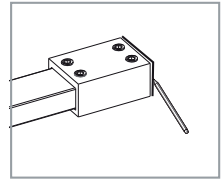
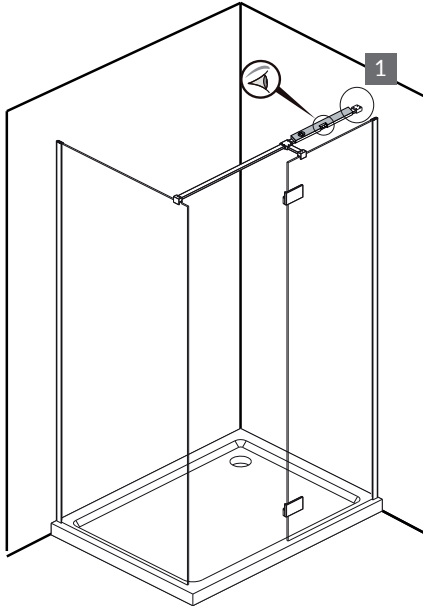
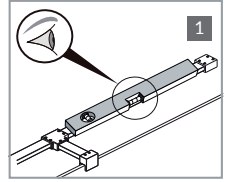
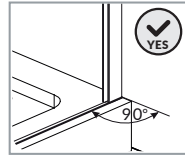
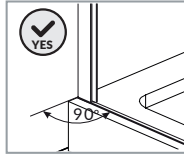
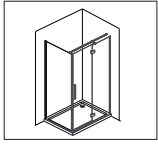

P9 x1

4X35 x4 3mm x1 2.5mm x1



25.

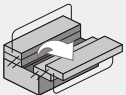
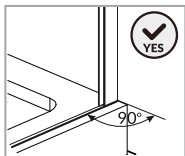
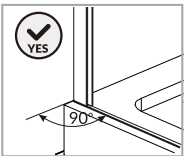
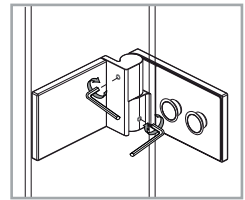
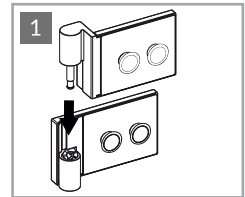
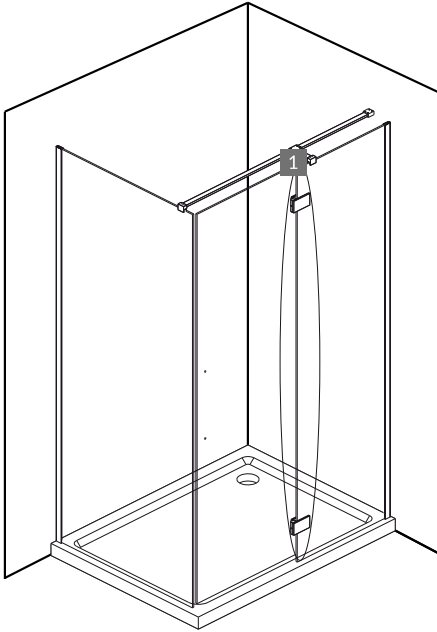
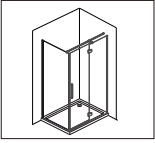

N



x1



26.

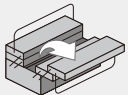
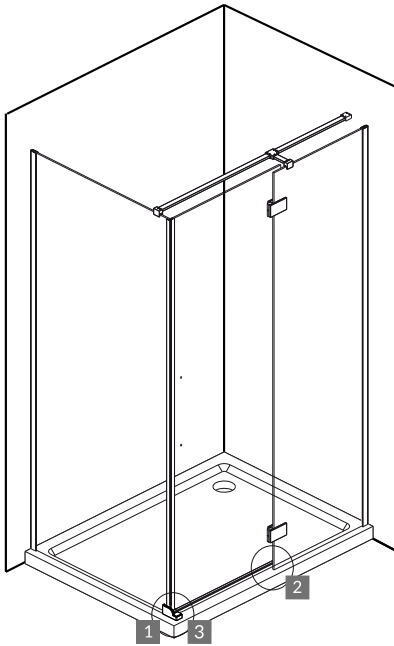
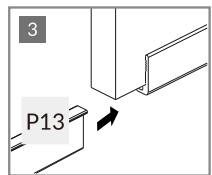
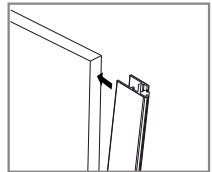
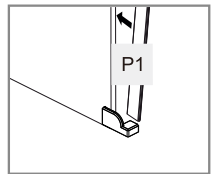
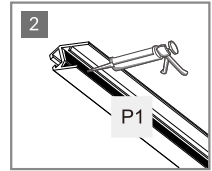
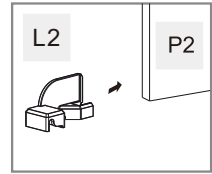
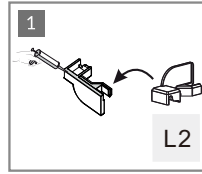
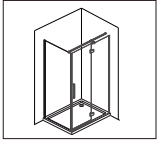

P1 ————— x1



P13 ————— x1

L2  x1

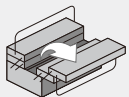
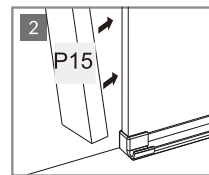
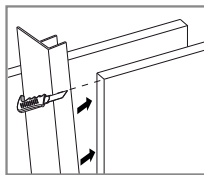
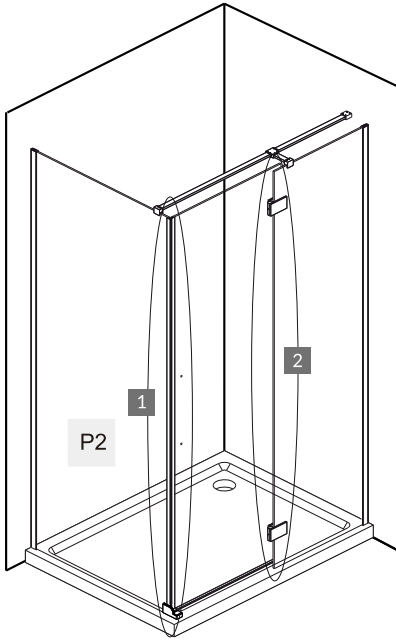
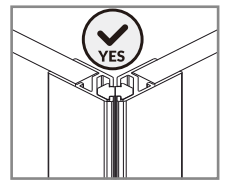
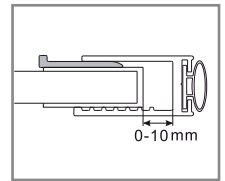
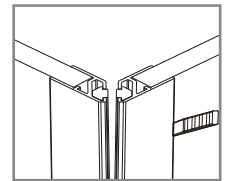
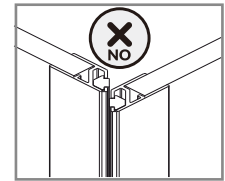
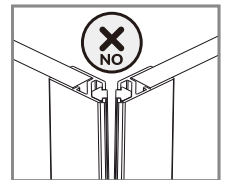
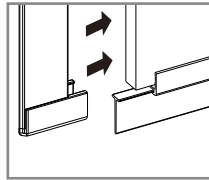
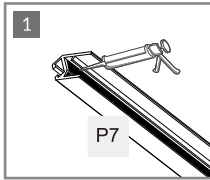
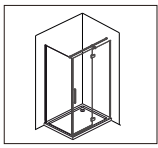

27.



- P7  x1
- P15  x1
- M  x1



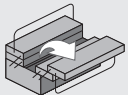
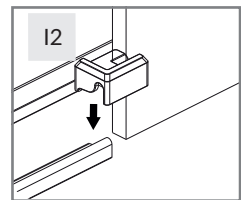
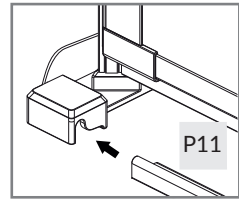
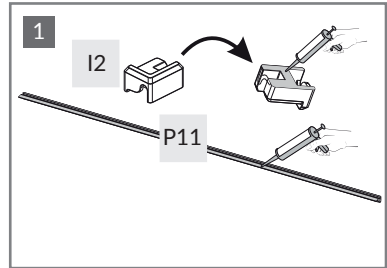
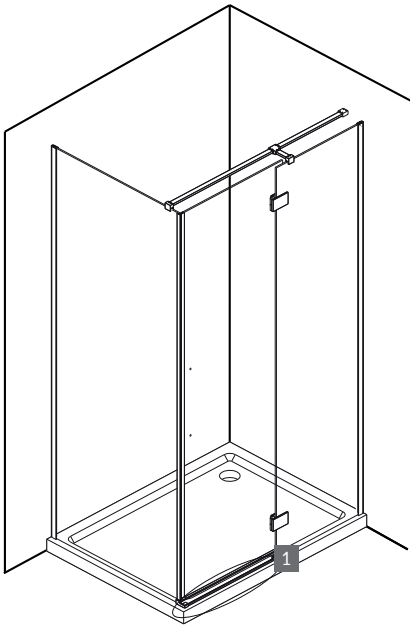
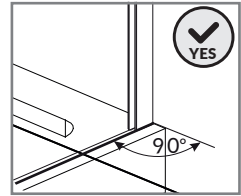
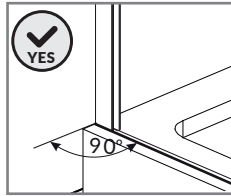
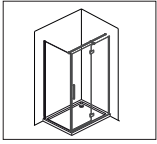

I2



x1

L2



x1

P11



x1



29.

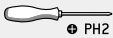
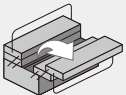
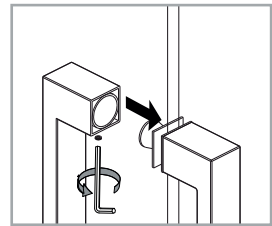
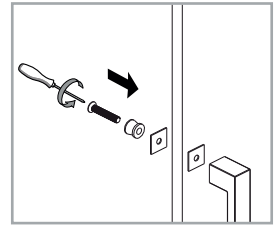
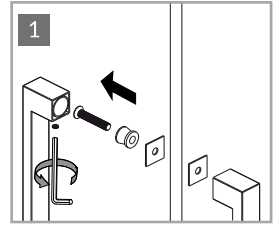
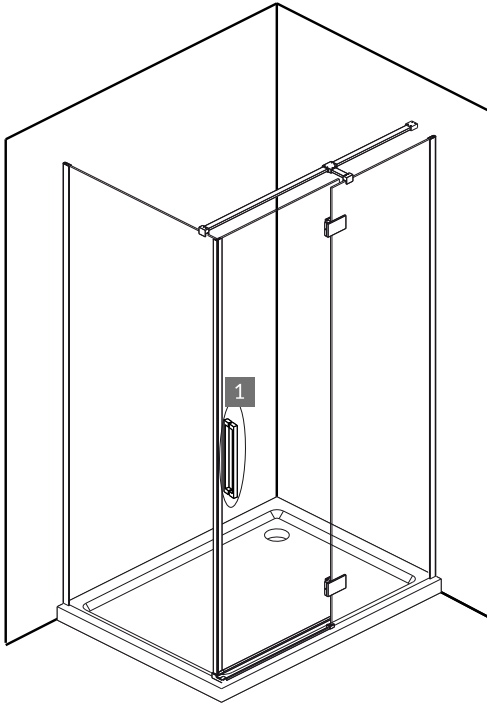
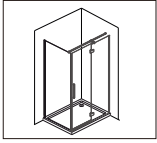

P14



x1



30.

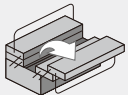
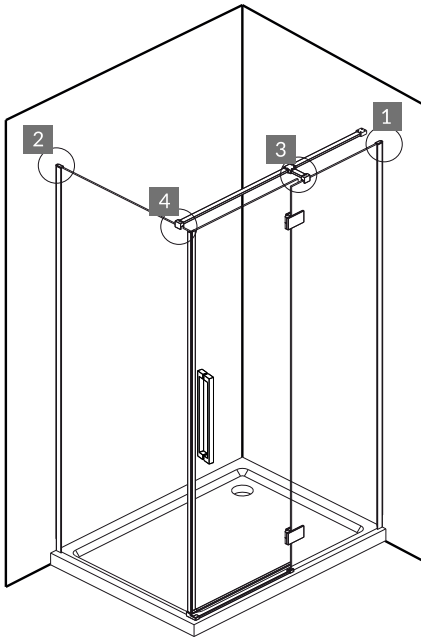
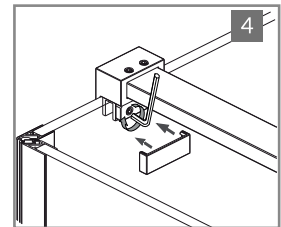
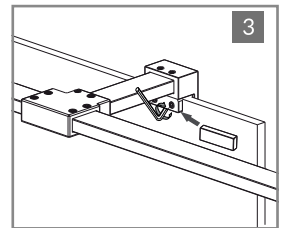
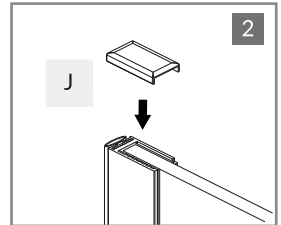
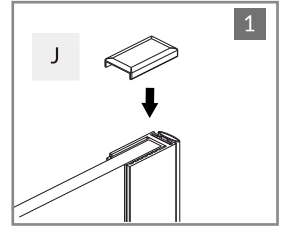
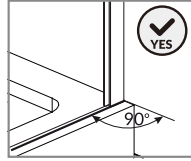
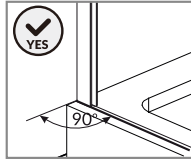
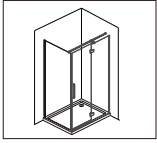

J



x2



31.

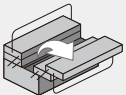
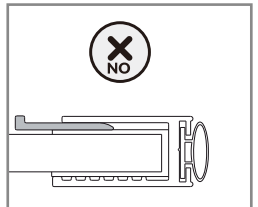
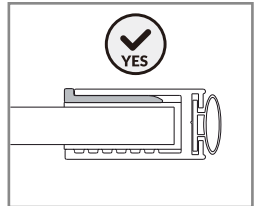
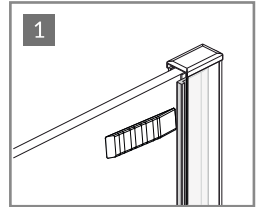
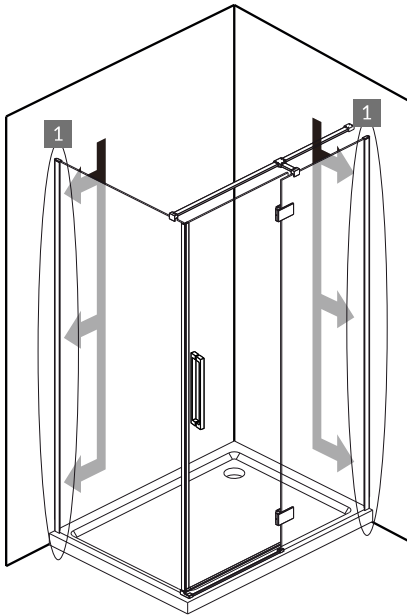
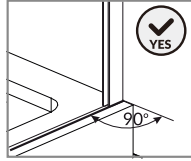
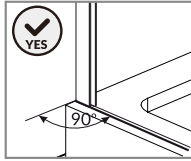
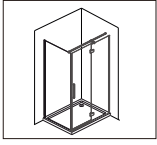

M



x1



32.

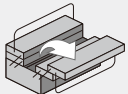
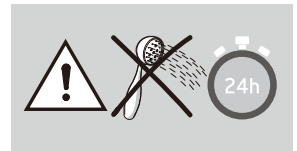
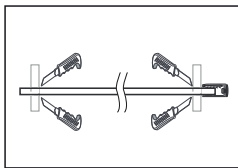
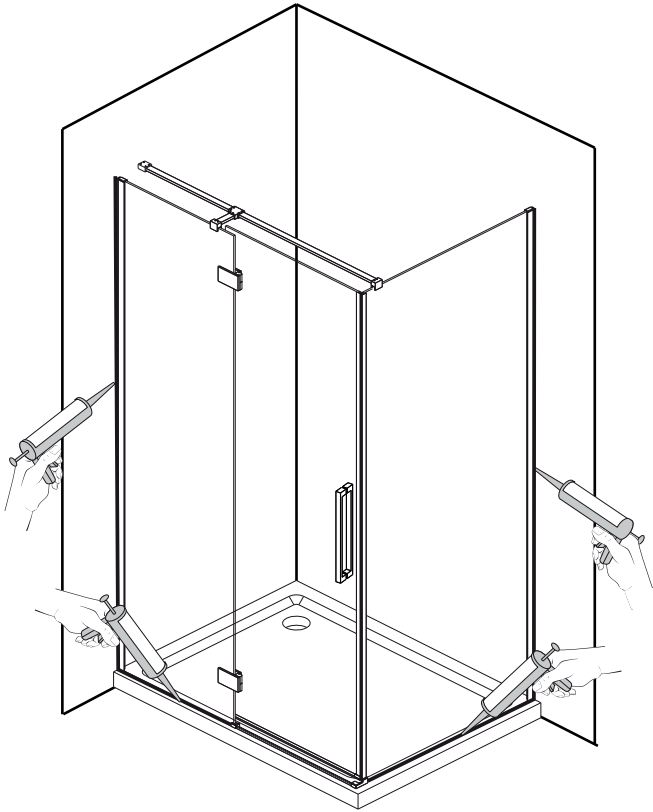
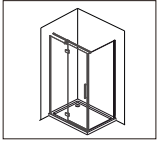



6.5 < PH < 7.5

