

TECE data sheet

Status as of 04.05.2019



TECEone toilet ceramics with shower function

Article number: 9700200

DU 1: 1 pc.

DU 2: 4 pc.

Description:

Rimless toilet ceramic with integrated shower function to clean bottoms comfortably with water. Shower function operates without electricity using warm and cold water connections installed on site. Wall-mounted toilet ceramic.

Shower function features:

- Intuitively control the water temperature and quantity using the integrated rotary selector switches
- Continuously adjust the amount of water up to 5.6 litre/min
- Water temperature individually, continuously adjustable (10-38 °C)
- Self-cleaning shower nozzles
- Replaceable shower nozzle caps
- In accordance with DIN EN 1717
- Minimum flow pressure 1 bar (max. 10 bar)

Toilet ceramic features:

- Wall-mounted toilet pan with 6 and 4.5 litre flush volume
- Compact design - depth from the wall 540 mm, mounting area 180 mm
- Concealed wall mounting and concealed water connections
- Rimless ceramic bowl with integrated splash guard
- Pre-assembled secure toilet seat attachment for TECEone toilet seat with lid
- Material: White toilet ceramic
- Optimal hygienic ceramic design with fewer corners, edges and joins
- In accordance with DIN EN 997
- Dimensions (W x H x D):
- 358 x 350 x 540 mm

Delivery package:

- Toilet ceramic including concealed wall mounting
- Pre-assembled toilet seat attachment
- Pre-assembled control buttons
- Reinforced hoses for the water connections at the standard corner valves

Sales data:

Commodity group:	TECEone toilet ceramics with shower function low flushing, white
Product group:	950
	2009500020

TECE data sheet

Status as of 04.05.2019

Dimensional drawings:

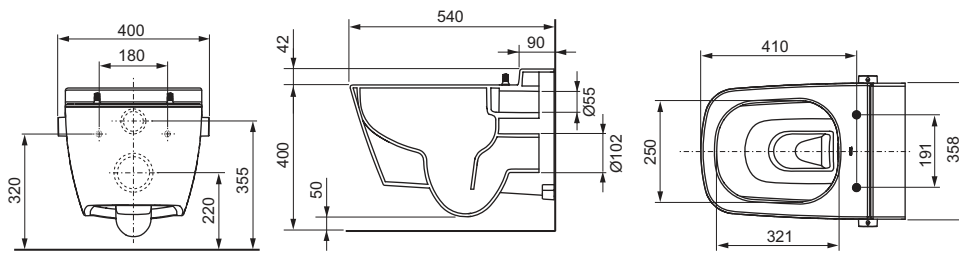

Spare parts:

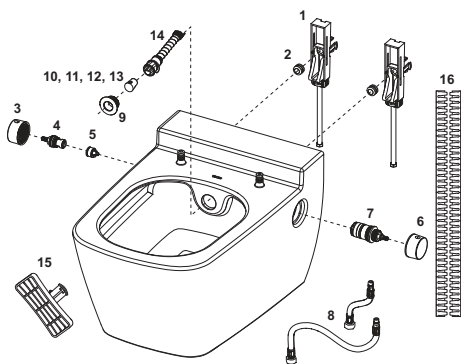

- | | | |
|----|---------|--|
| 1 | 9820356 | Concealed mounting |
| 2 | 9820357 | Knurled nut (2 x) for concealed mounting |
| 3 | 9820362 | Operating knob water volume |
| 4 | 9820358 | Ceramic cartridge |
| 5 | 9820359 | Protective device to DIN EN 1717 |
| 6 | 9820361 | Operating knob temperature |
| 7 | 9820360 | Thermostatic cartridge |
| 8 | 9820365 | Reinforced hoses hot and cold |
| 9 | 9820364 | Rosette |
| 10 | 9820403 | Shower nozzle cap (3 x) "standard" 75° |
| 11 | 9820404 | Shower nozzle cap (3 x) "standard" 90° |
| 12 | 9820405 | Shower nozzle cap (3 x) "medium" 90° |
| 13 | 9820406 | Shower nozzle cap (3 x) "small" 90° |
| 14 | 9820363 | Shower arm complete set |
| 15 | 9820422 | Removal tool shower arm |
| 16 | 9820351 | Sound insulation tape |