

INSTALLATION

XETIS INSTALLATION SETS 1, 2 OR 3

Waste fitting KA 200

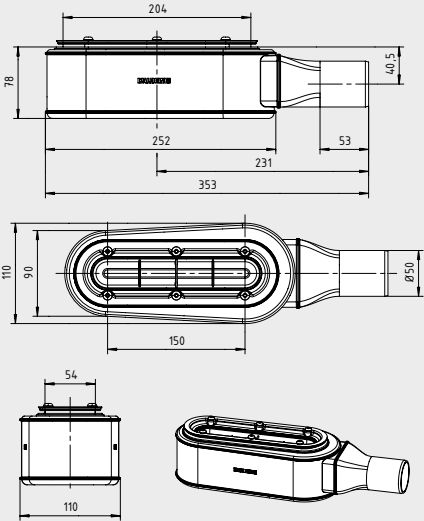

Installation cover



XETIS sealing system XDS

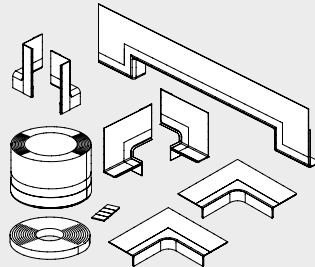

Designer cover for tiling (included in installation set 1)

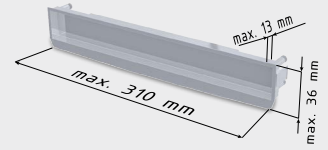

Order No.
687676260000

or

Designer cover polished chrome plate (included in installation set 2)



Order No.
687676270000

or

Designer cover, polished chrome, with collar* (included in installation set 3)



Order No.
687676370000

| XETIS installation sets | Order No. | EUR |
|----------------------------------------------------------------------------------------------------------------------------------------------------------------------------------------------------------------------------|--------------|-----|
| XETIS installation set 1 with designer cover for tiling includes waste fitting KA 200, XETIS sealing system XDS, installation cover, designer cover for tiling | 687676310000 | |
| or | | |
| XETIS installation set 2 with designer cover polished chrome plate includes waste fitting KA 200, XETIS sealing system XDS, installation cover, designer cover polished chrome plate | 687676320000 | |
| or | | |
| XETIS installation set 3 with designer cover, polished chrome, with collar* includes waste fitting KA 200, XETIS sealing system XDS, installation cover, designer cover polished chrome plate with collar | 687676390000 | |

XETIS INSTALLATION SOLUTION MAS 5305 CENTRAL SUPPORT SYSTEM

Number and positioning:

1 x MAS

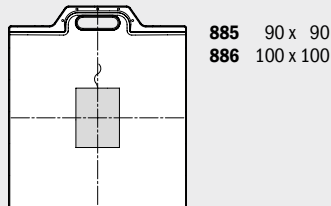

2 x MAS

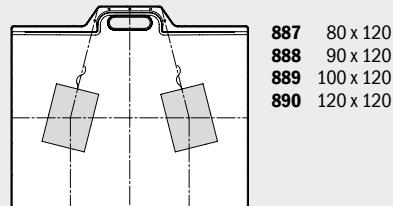

3 x MAS

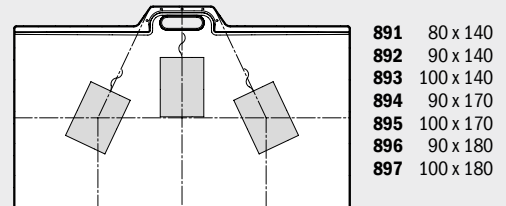

| Central support system MAS 5305 | Order No. | EUR |
|-------------------------------------------------------------------------------------------------------------------------------------------------------------------------------------------------------------------------------------------------------------------------------------------------------------------------------------------------------------------------------------------------------|--------------|-----|
| Recommended for shower trays with assembly or installation frame FR 5300 FLEX whose side length is 90 cm and longer. 240 x 300 mm (W x L), Height: 48 to 135 mm (adjustable). Set comprising: 2 x double-sided adhesive tape 1 x upper wedge 1 x lower wedge 1 x pull plate (ready-mounted) 1 x pull cord (ready-mounted) 1 x adapter panel 40 mm 1 x adapter panel 20 cm | 688076530000 | |

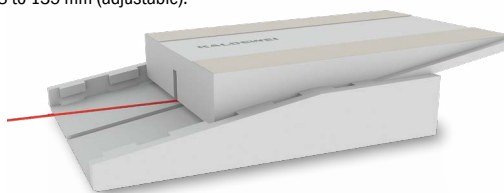

To meet the strict requirements of DIN 4109 - Sound insulation in buildings and VDI 4100/SST3, please use the XETIS sound insulation solution; see page 310.