

HL800P/63-75 DN63-75

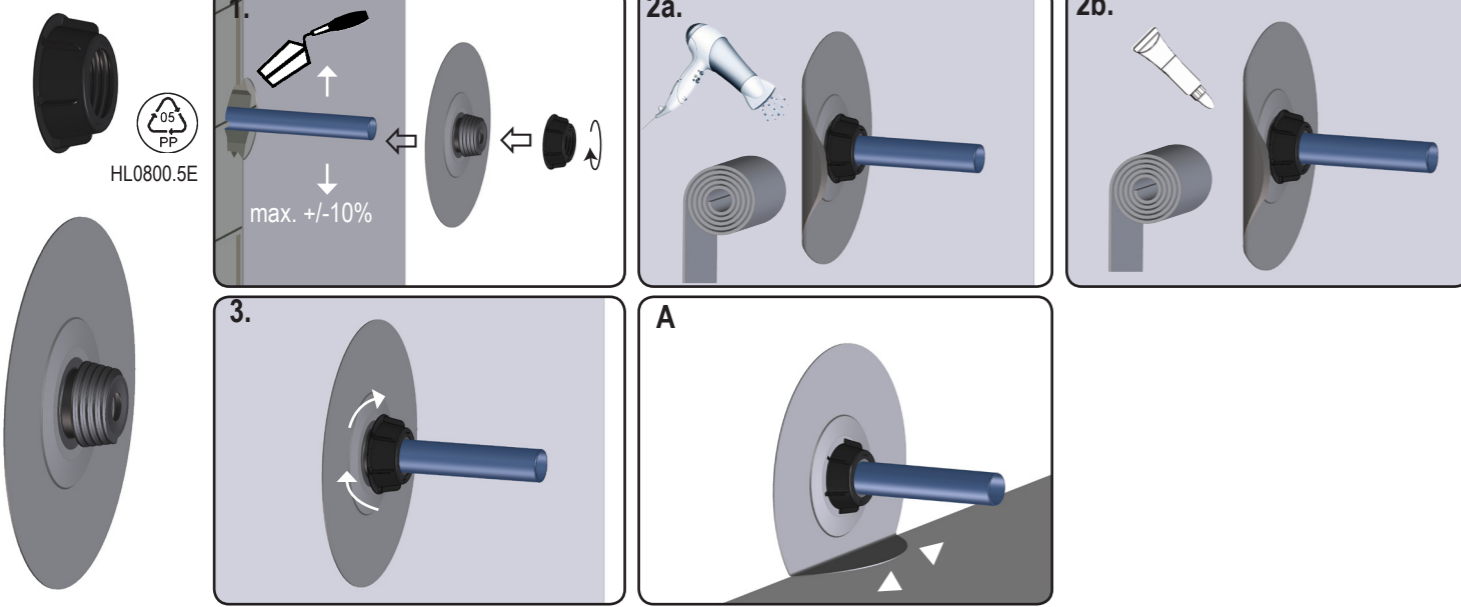
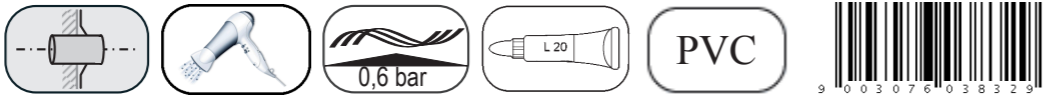

DE Rohrdurchführung
IT Condotto
GB Pipe penetration collar
TR Boru geçişi
CZ Přechod pro vstup potrubí
HR Cijevni prolaz
HU Csőátvezetés
PL Przejście dla rur
SLO Cevni prehod
RO Teavă de trecere
RUS Подземный ввод трубопроводов
BUL ПРЕХОДНИК ЗА ТРЪБИ

01.07.2014

HL800P/63-75 DN63-75

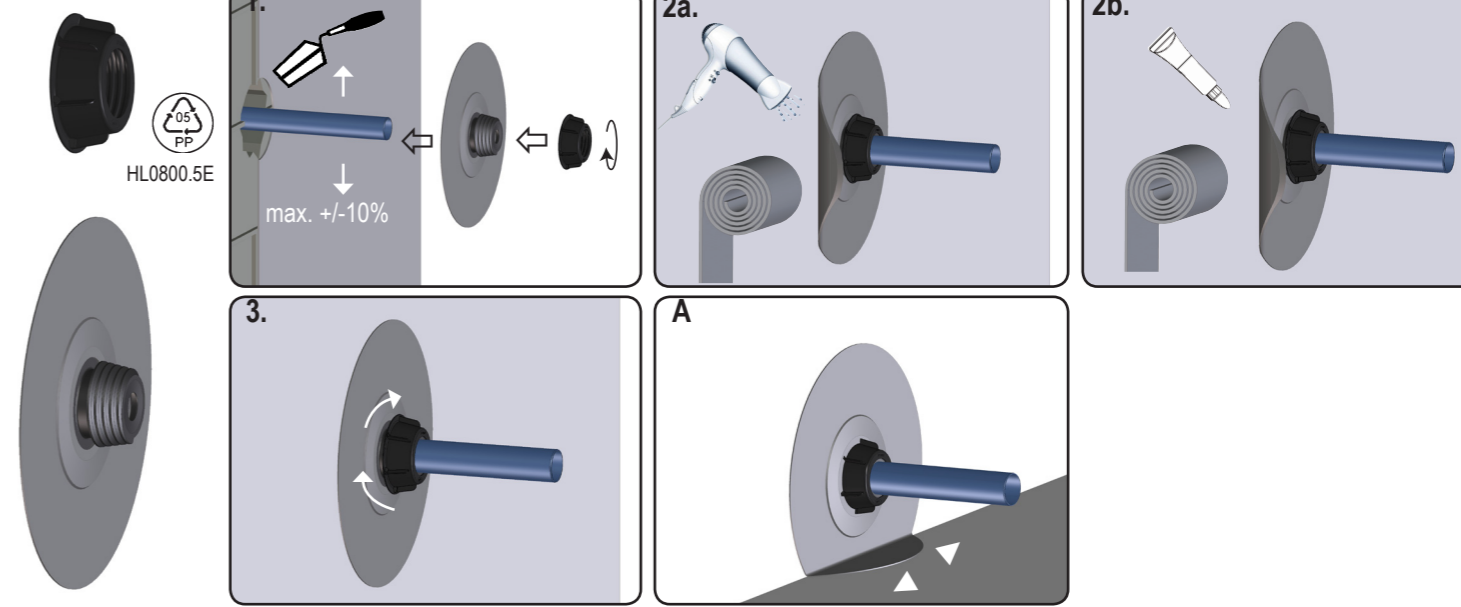
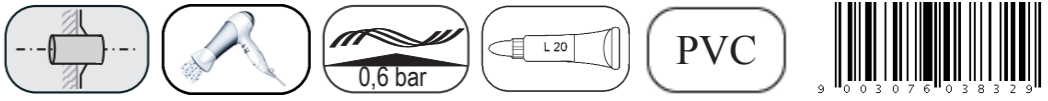

DE Rohrdurchführung
IT Condotto
GB Pipe penetration collar
TR Boru geçişi
CZ Přechod pro vstup potrubí
HR Cijevni prolaz
HU Csőátvezetés
PL Przejście dla rur
SLO Cevni prehod
RO Teavă de trecere
RUS Подземный ввод трубопроводов
BUL ПРЕХОДНИК ЗА ТРЪБИ

01.07.2014

HL800P/63-75 DN63-75

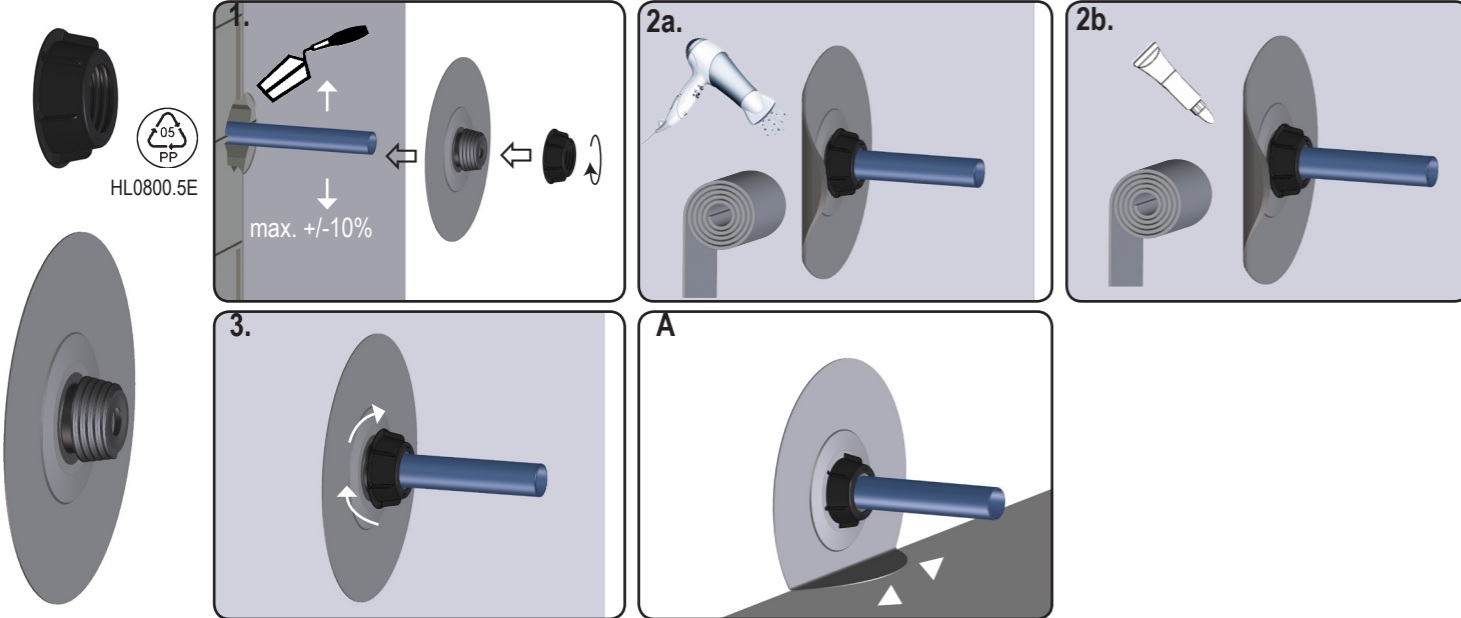
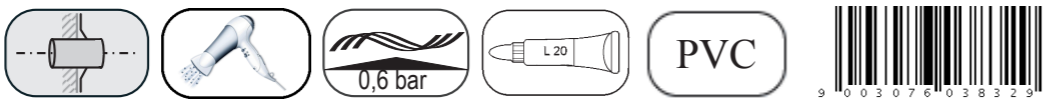

DE Rohrdurchführung
IT Condotto
GB Pipe penetration collar
TR Boru geçişi
CZ Přechod pro vstup potrubí
HR Cijevni prolaz
HU Csőátvezetés
PL Przejście dla rur
SLO Cevni prehod
RO Teavă de trecere
RUS Подземный ввод трубопроводов
BUL ПРЕХОДНИК ЗА ТРЪБИ

01.07.2014

HL800P/63-75 DN63-75

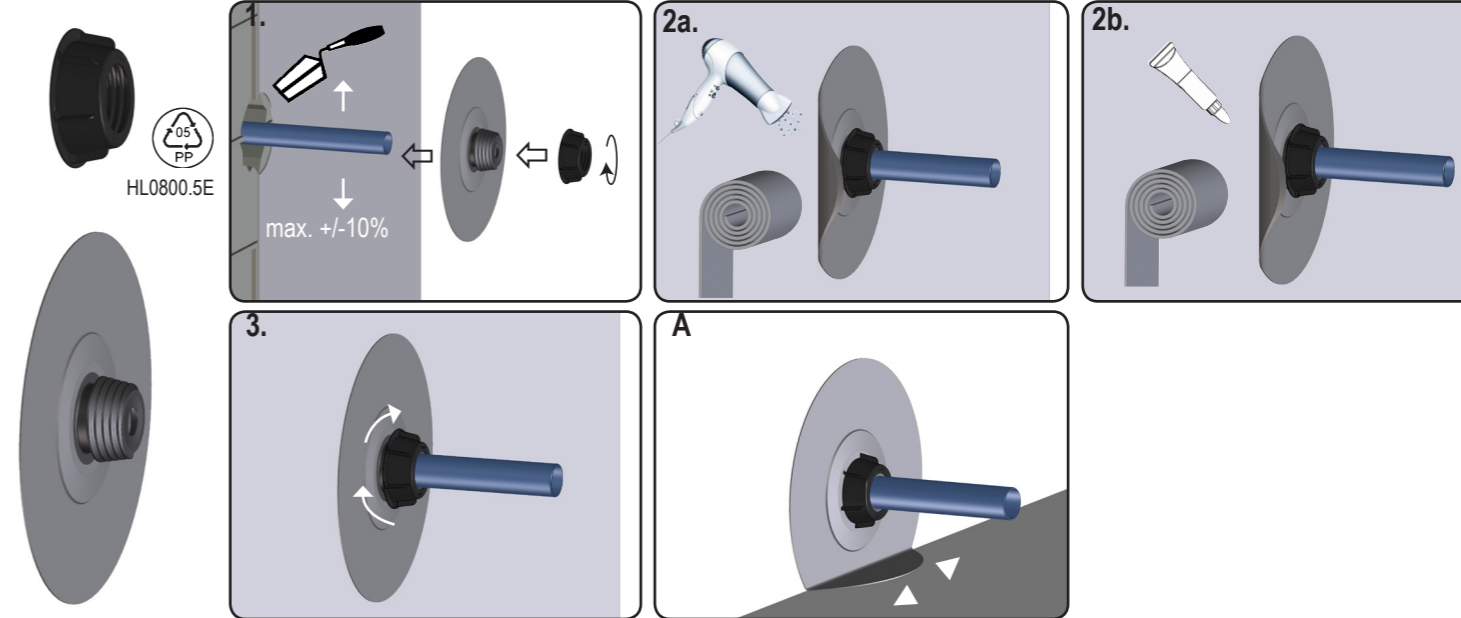
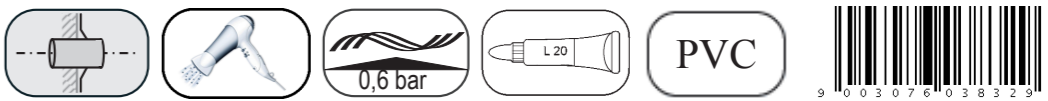

DE Rohrdurchführung
IT Condotto
GB Pipe penetration collar
TR Boru geçişi
CZ Přechod pro vstup potrubí
HR Cijevni prolaz
HU Csőátvezetés
PL Przejście dla rur
SLO Cevni prehod
RO Teavă de trecere
RUS Подземный ввод трубопроводов
BUL ПРЕХОДНИК ЗА ТРЪБИ

01.07.2014