

EFF2

 GEBERIT

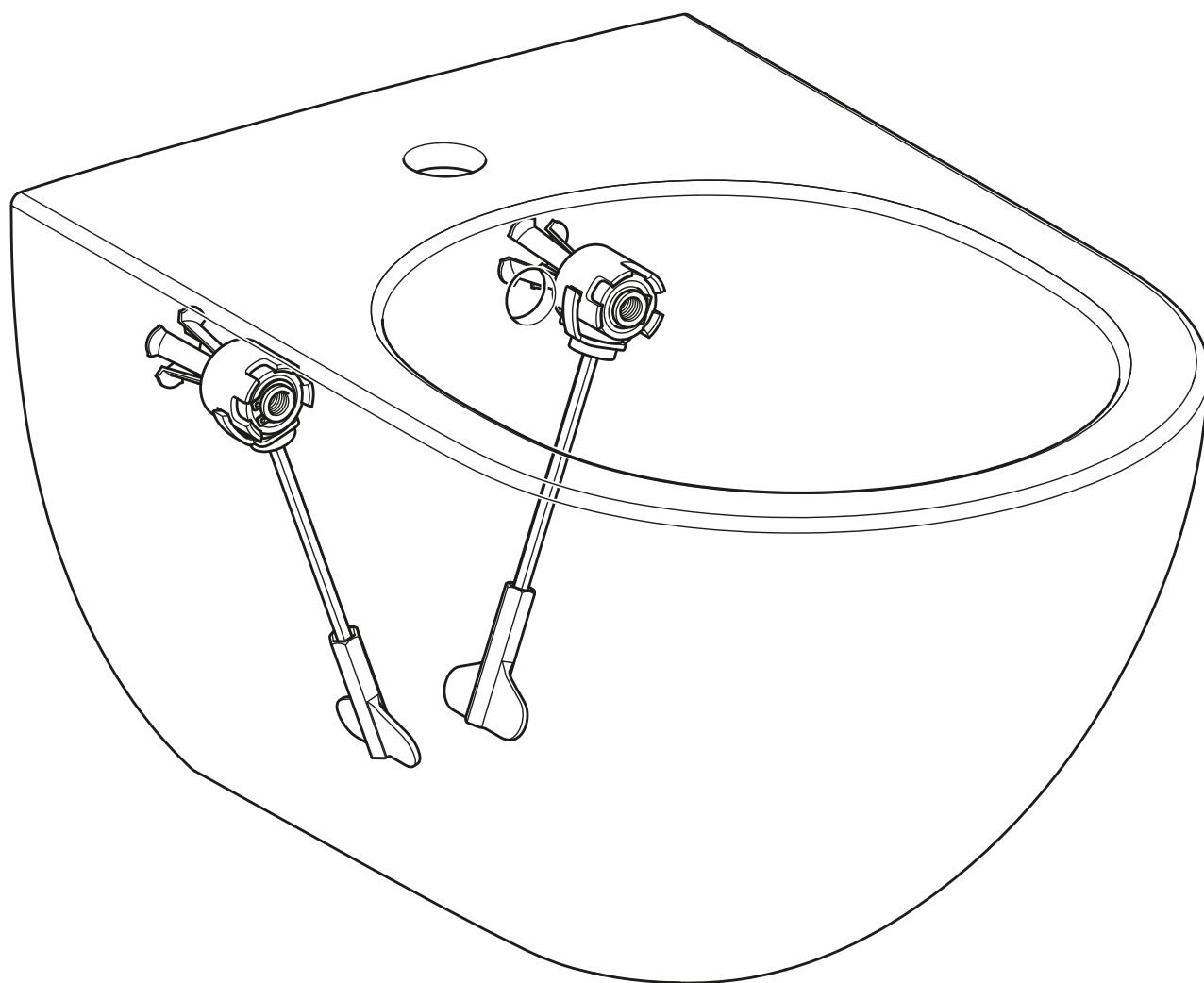

INSTALLATION MANUAL

MONTAGEANLEITUNG

INSTRUCTIONS DE MONTAGE

ISTRUZIONI PER IL MONTAGGIO





1

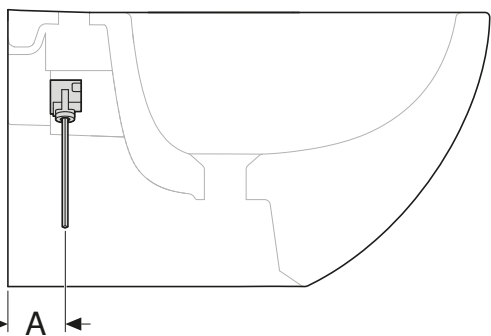
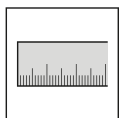

2

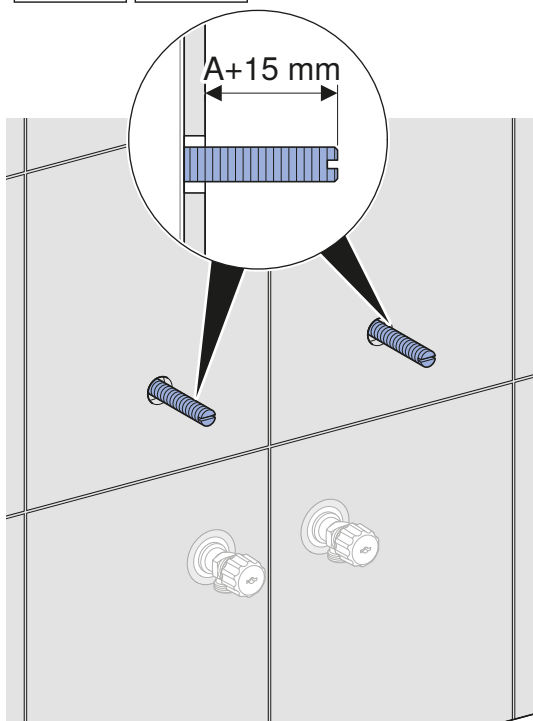
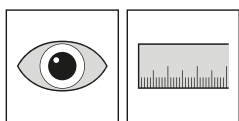

3

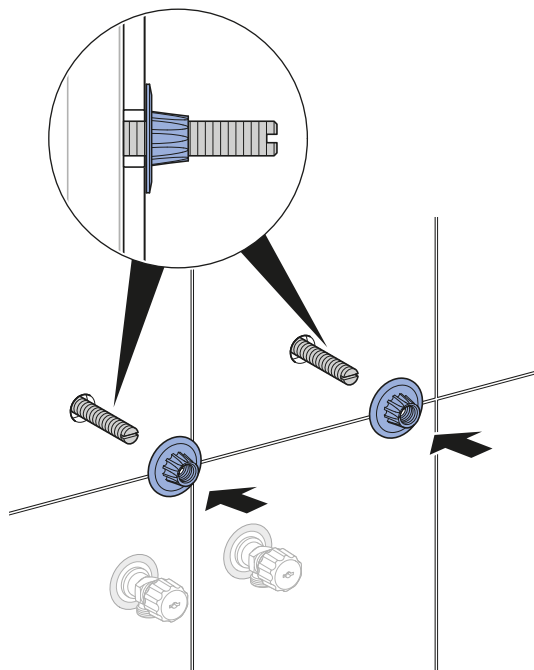

4

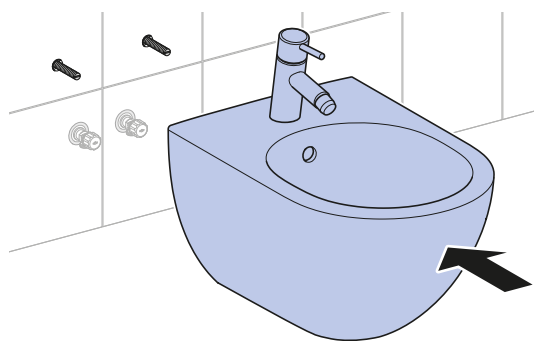

5

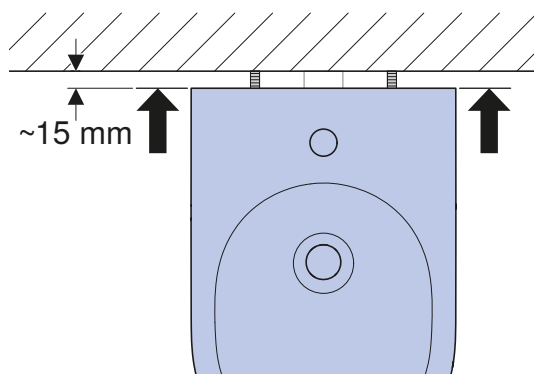
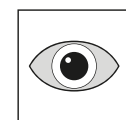

6

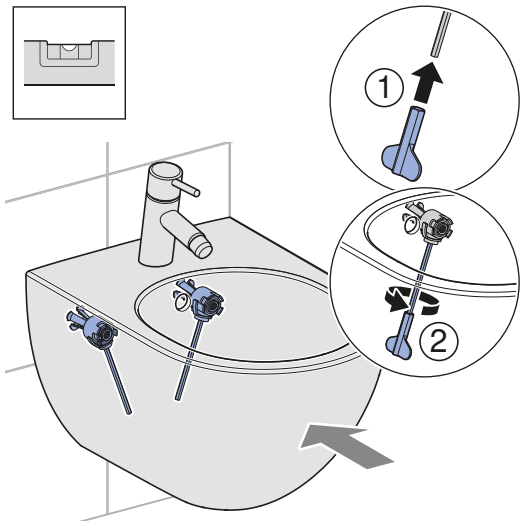

Geberit International AG
Schachenstrasse 77, CH-8645 Jona
documentation@geberit.com
www.geberit.com

