

# INSTALLATION MANUAL

MONTAGEANLEITUNG  
INSTRUCTIONS DE MONTAGE  
ISTRUZIONI PER IL MONTAGGIO

**KNOW  
HOW  
INSTALLED**

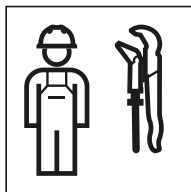



1

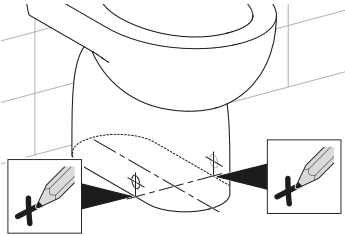

2

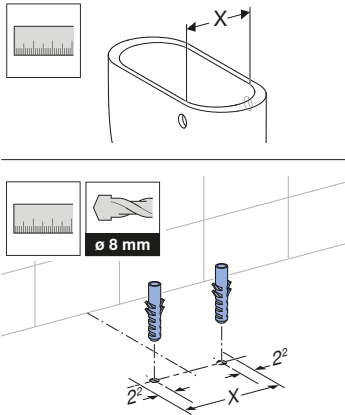

3

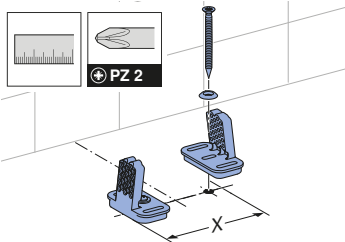

4

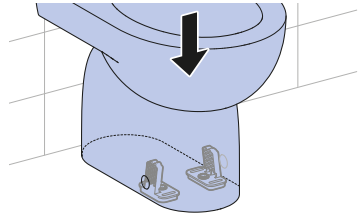

5

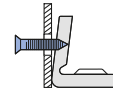
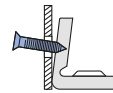
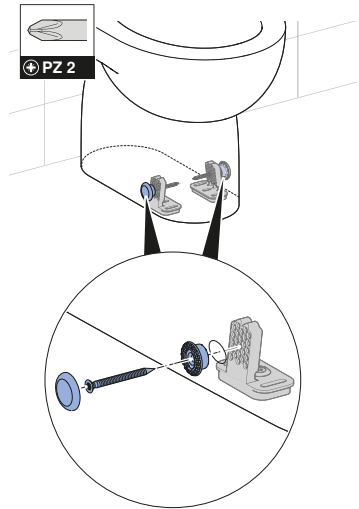

Geberit International AG  
Schachenstrasse 77, CH-8645 Jona  
documentation@geberit.com  
www.geberit.com

