

# Installation

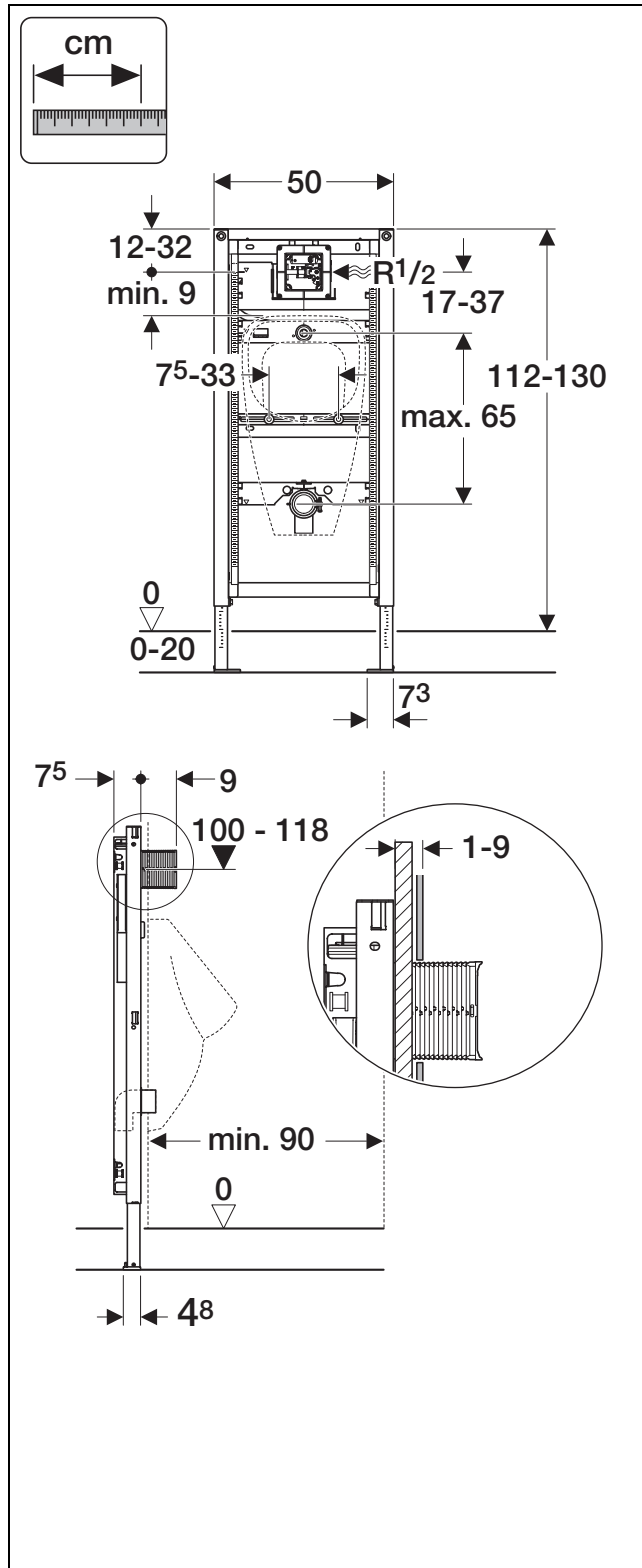

D19932-001&BDC © 07-2008

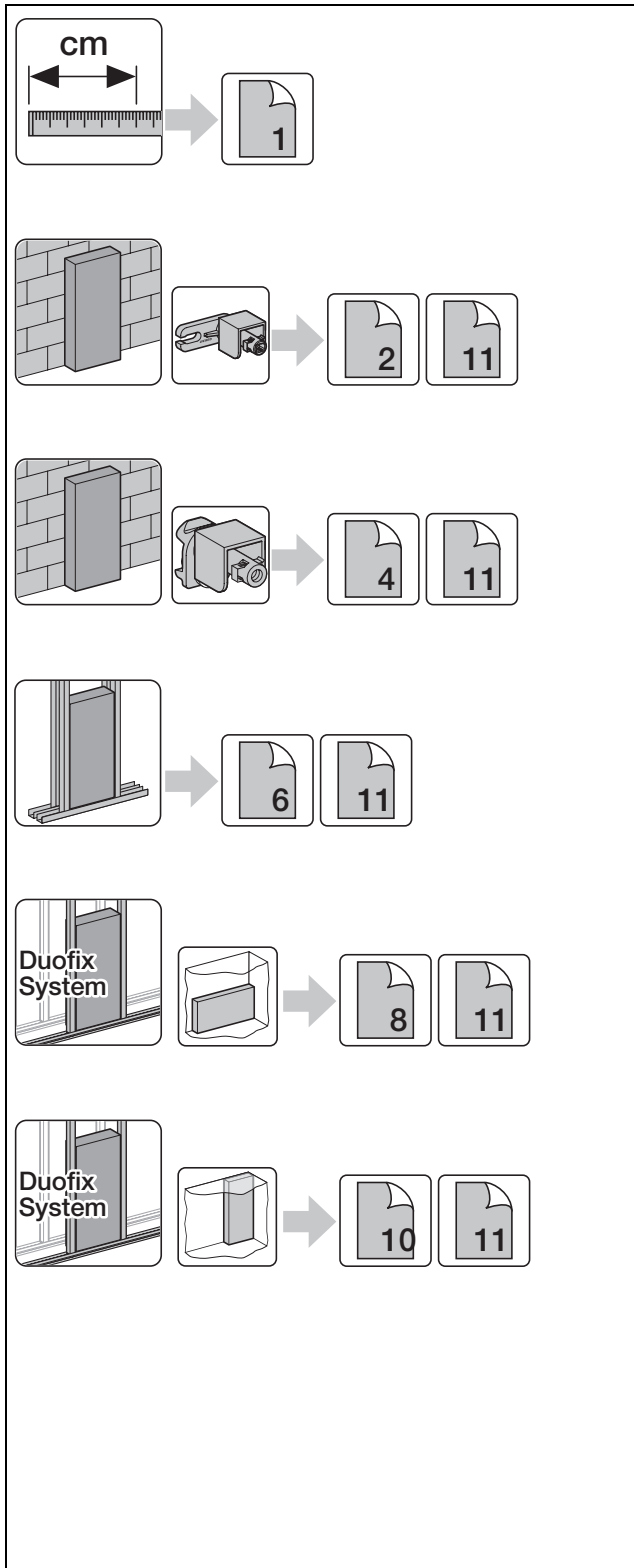

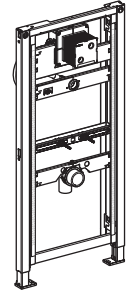
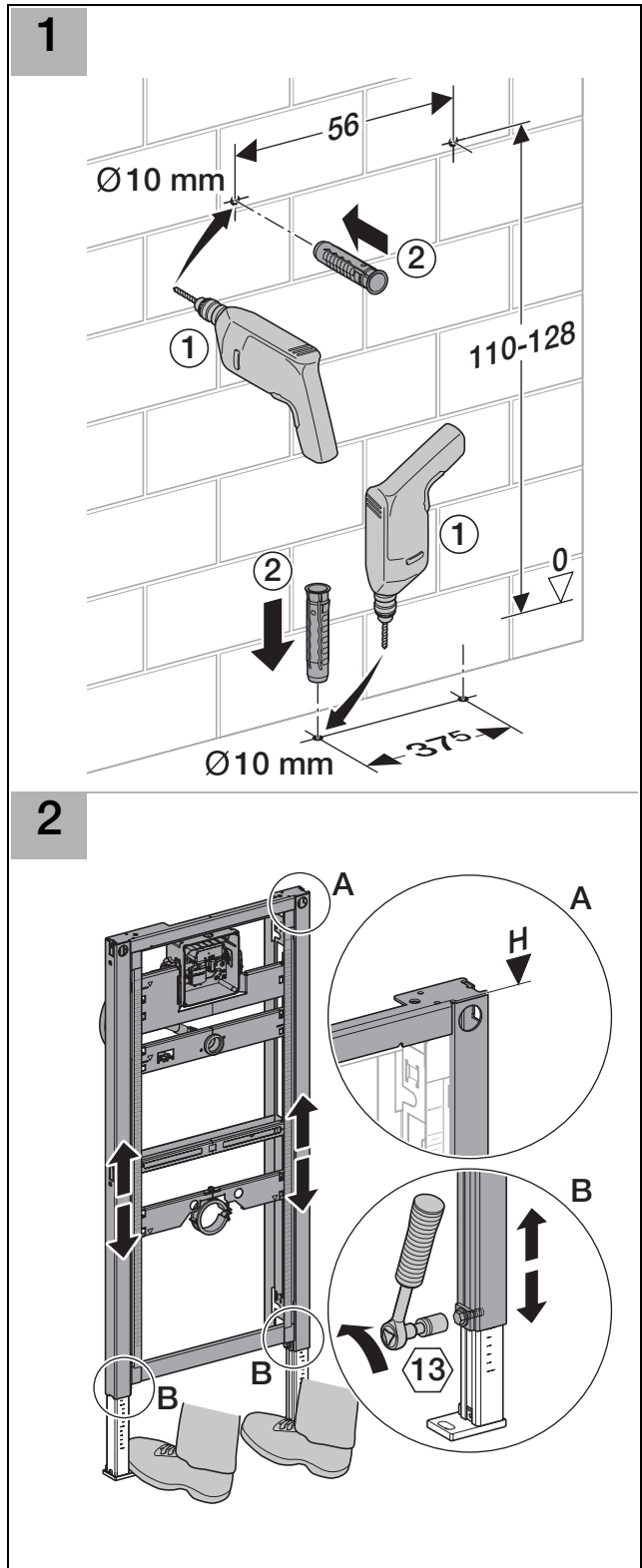
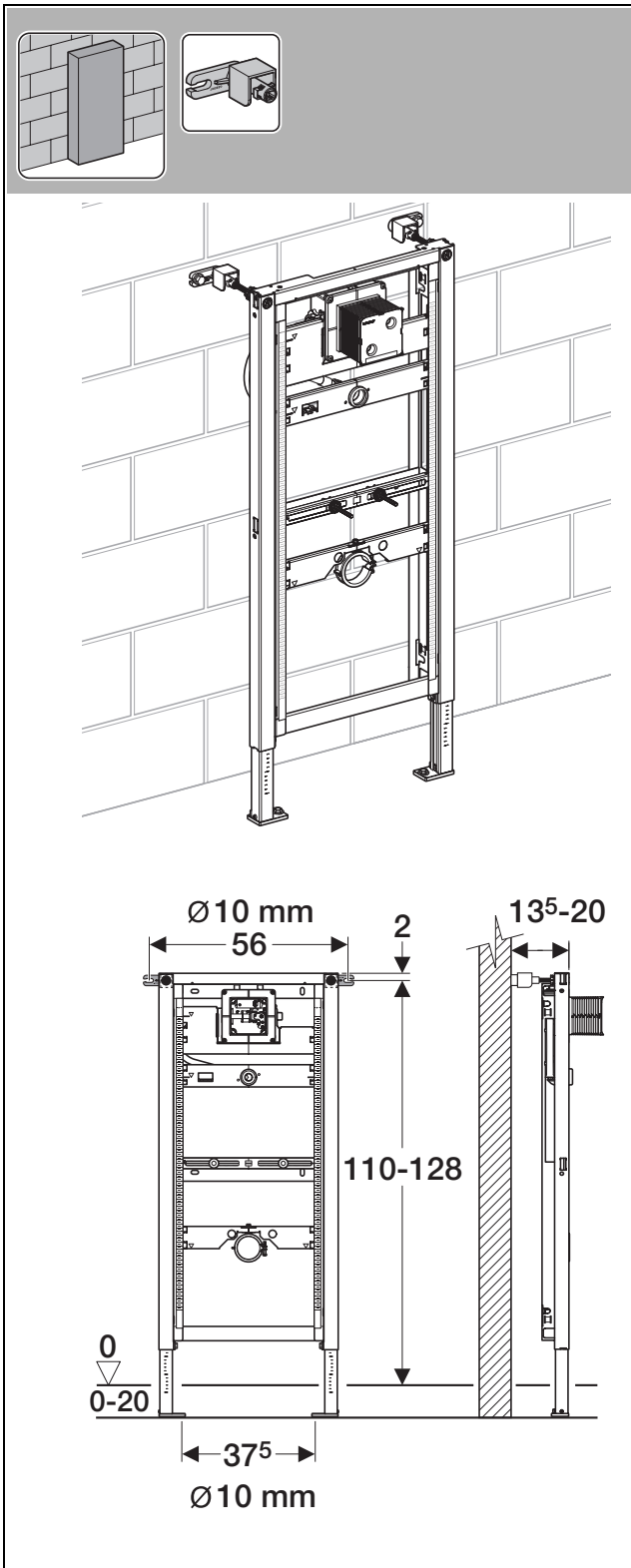
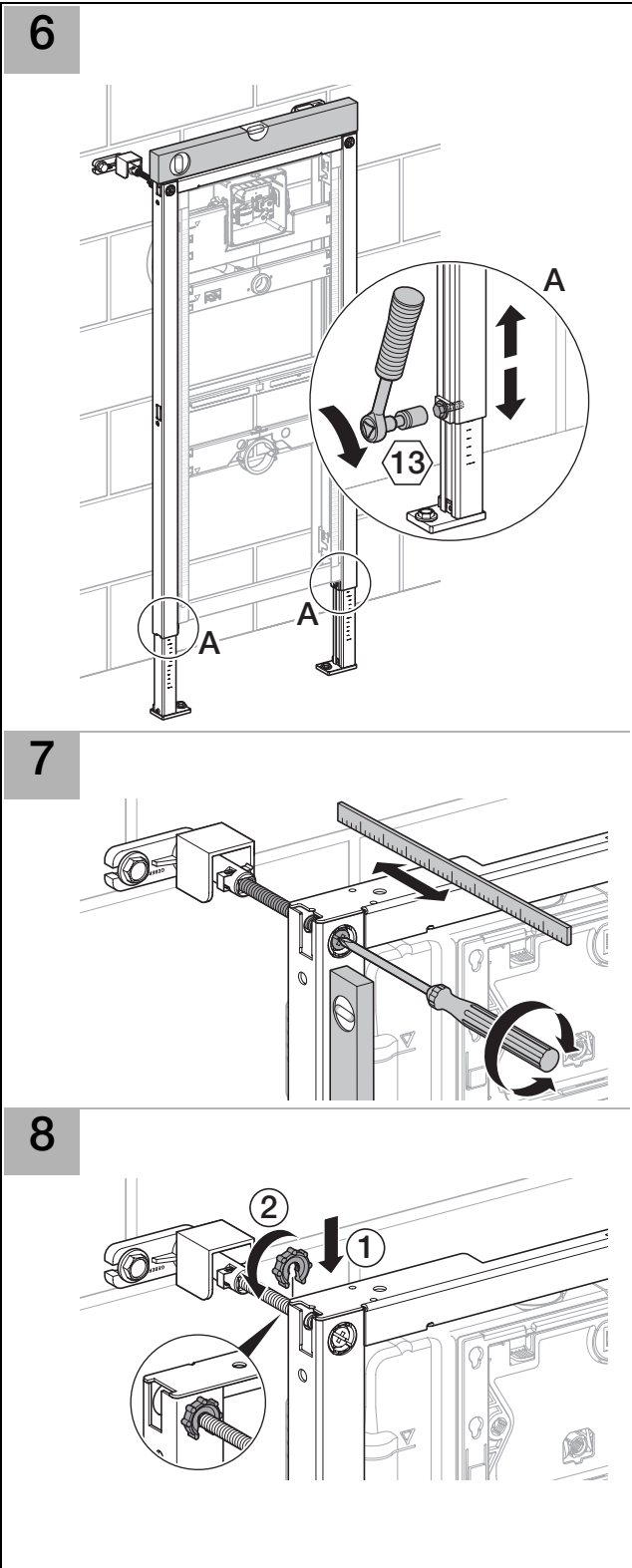
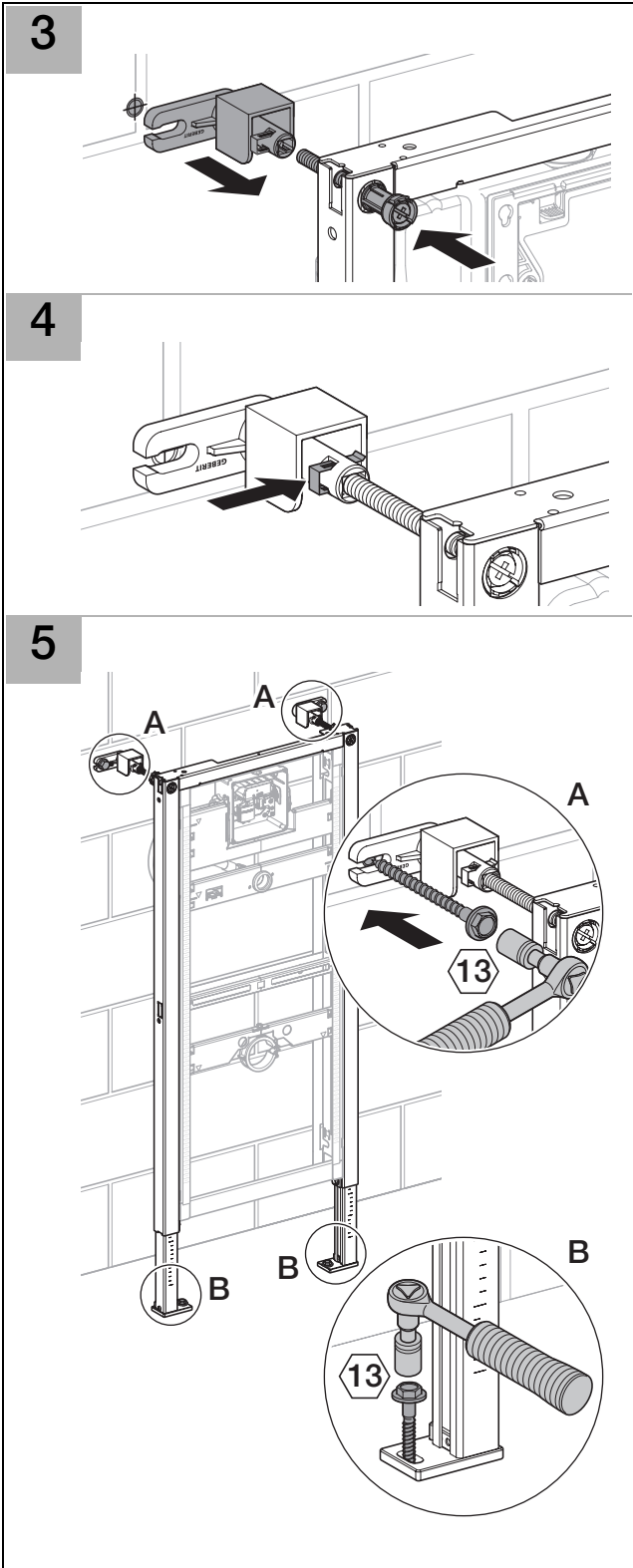

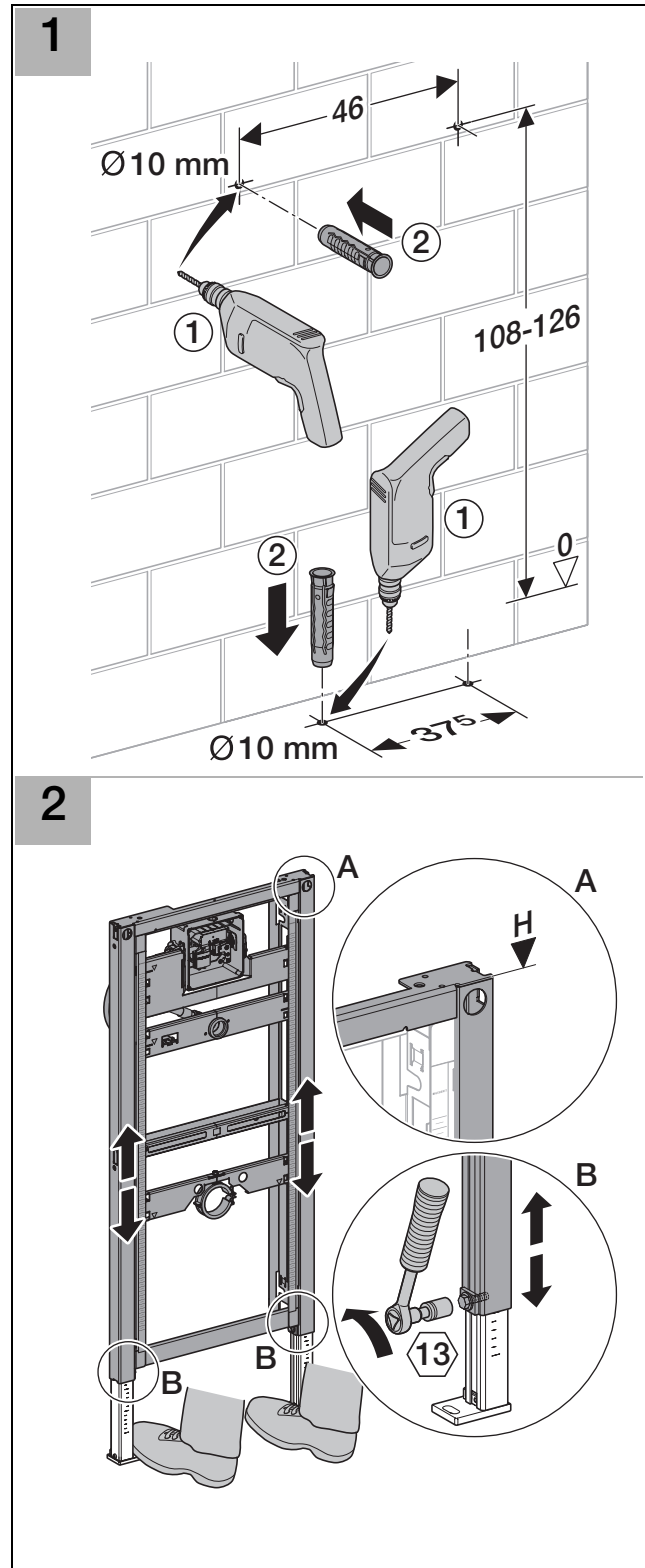
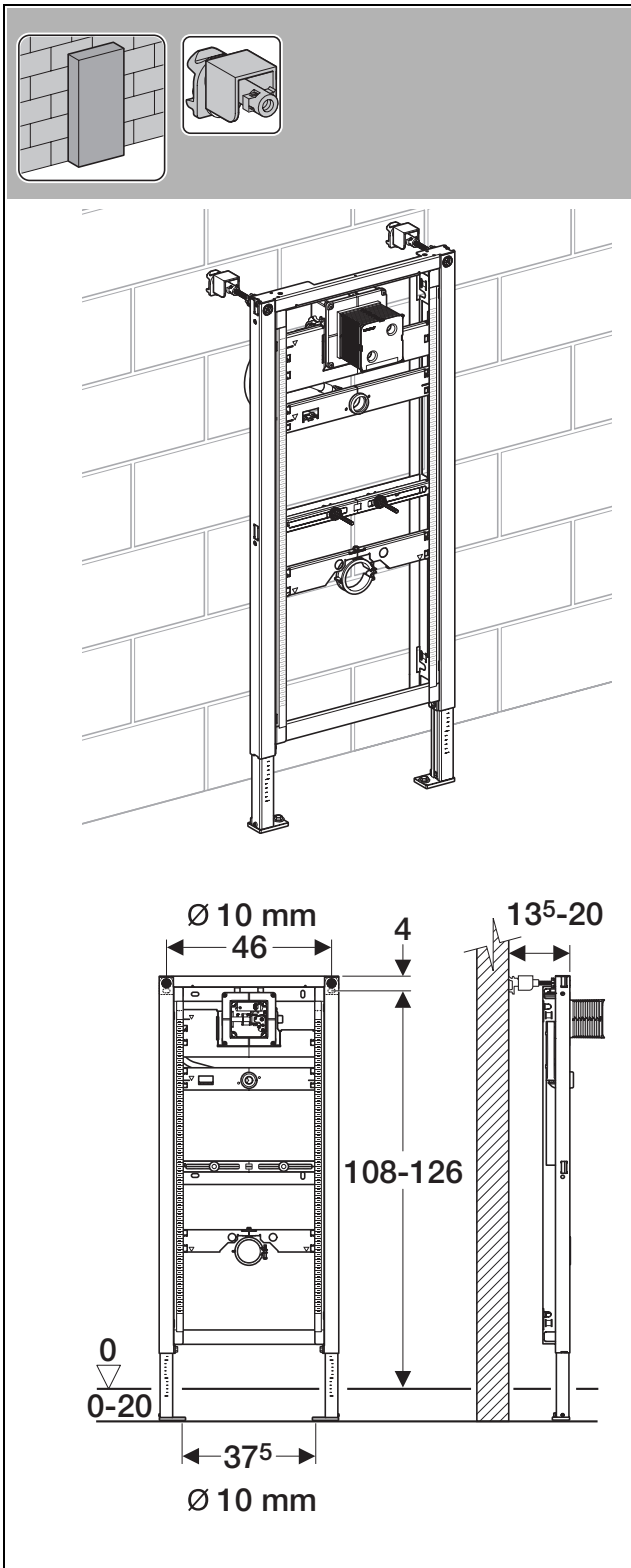

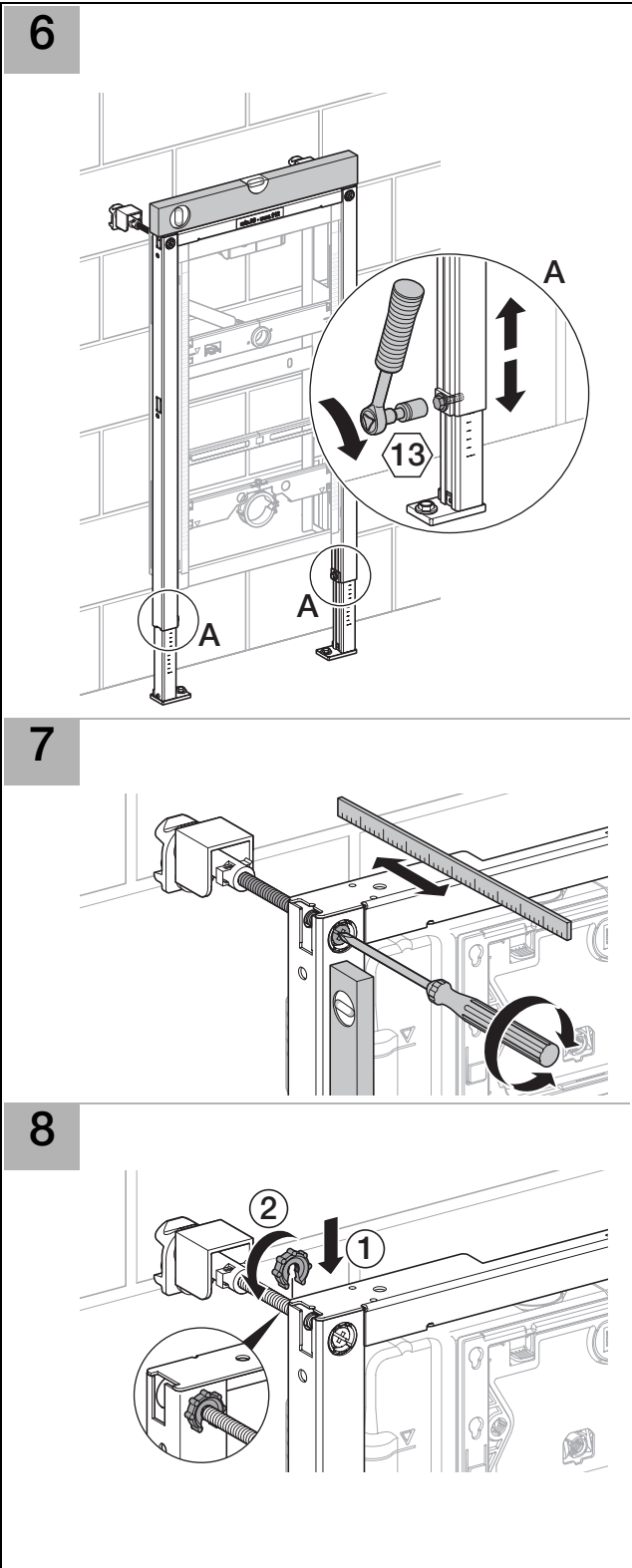
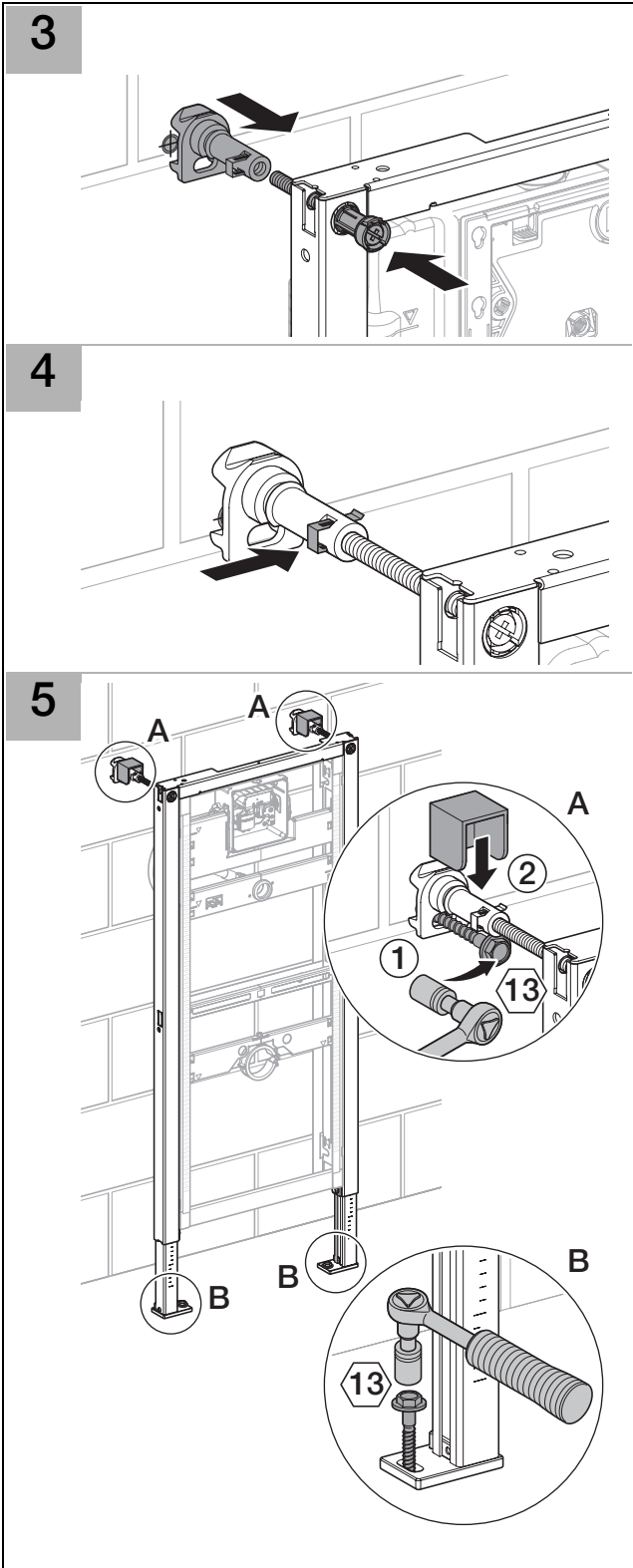

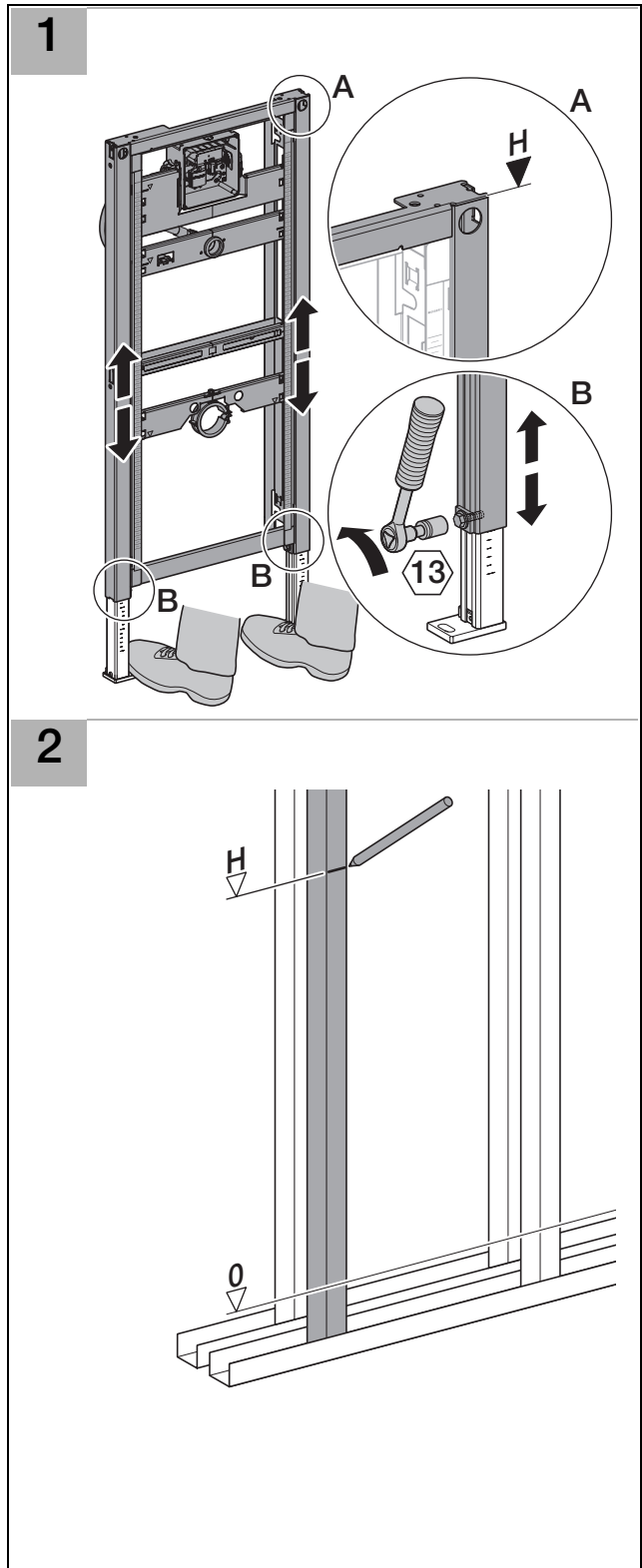
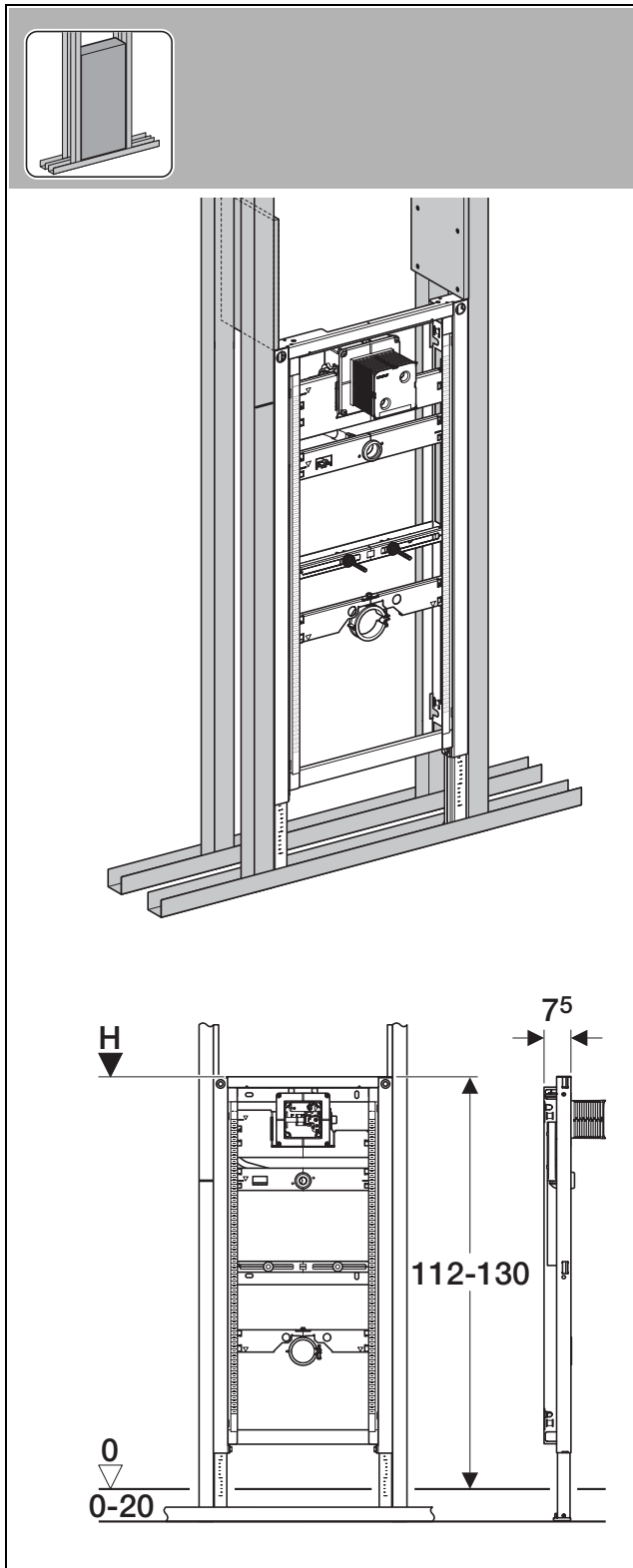

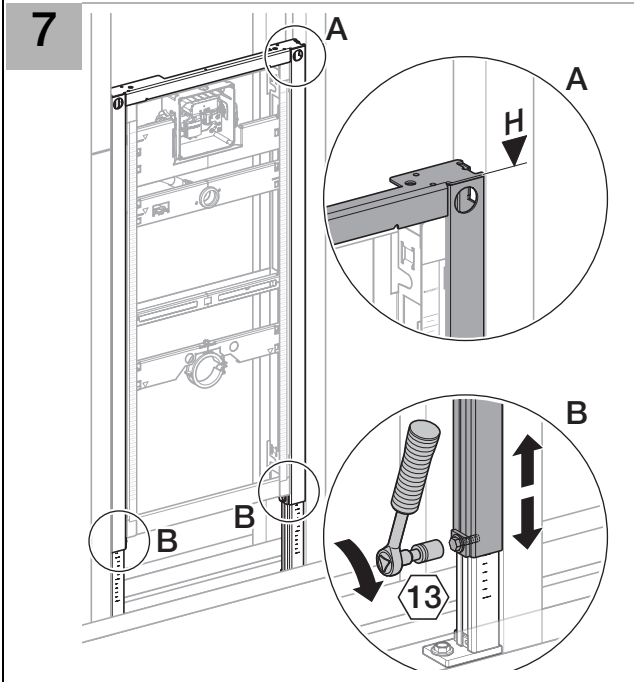
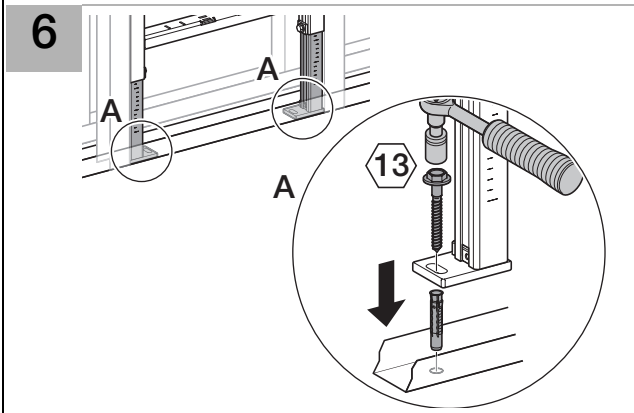
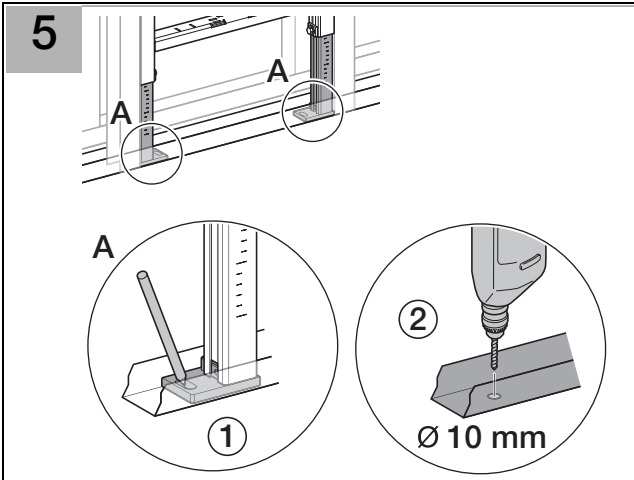
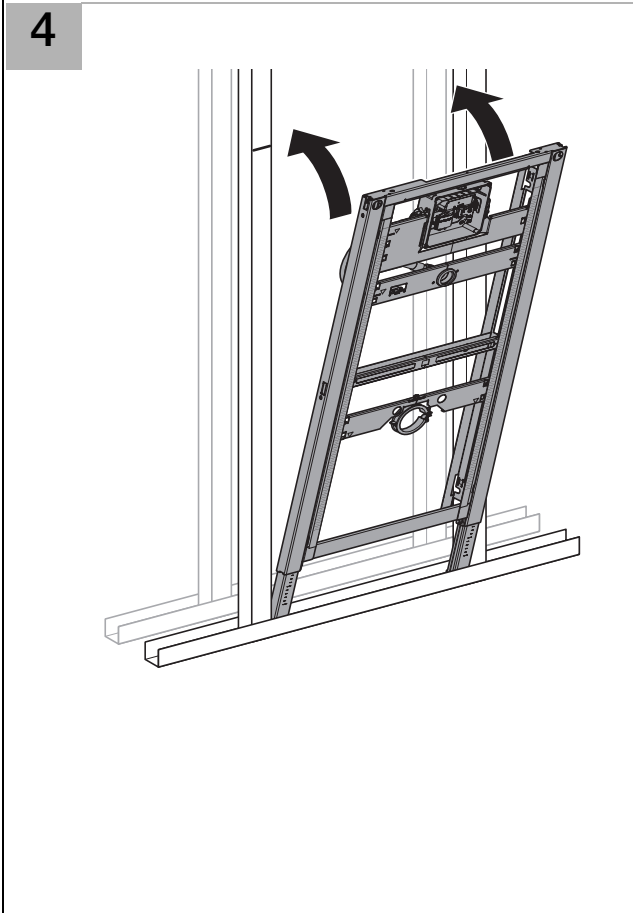
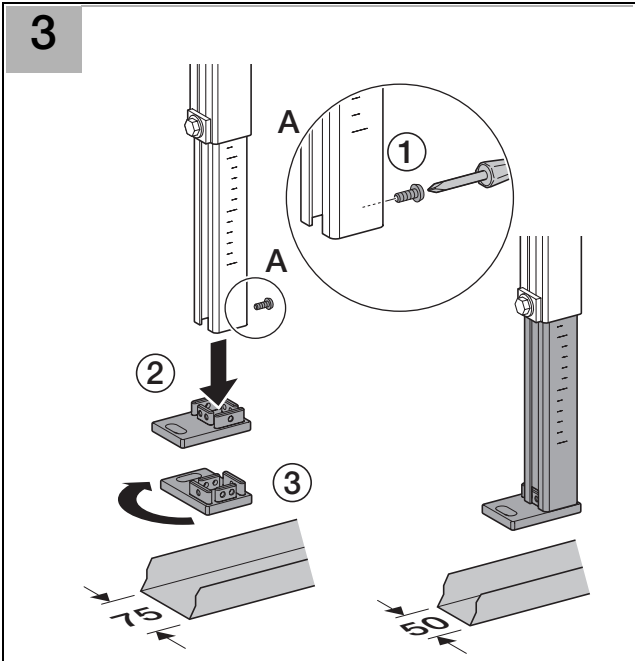

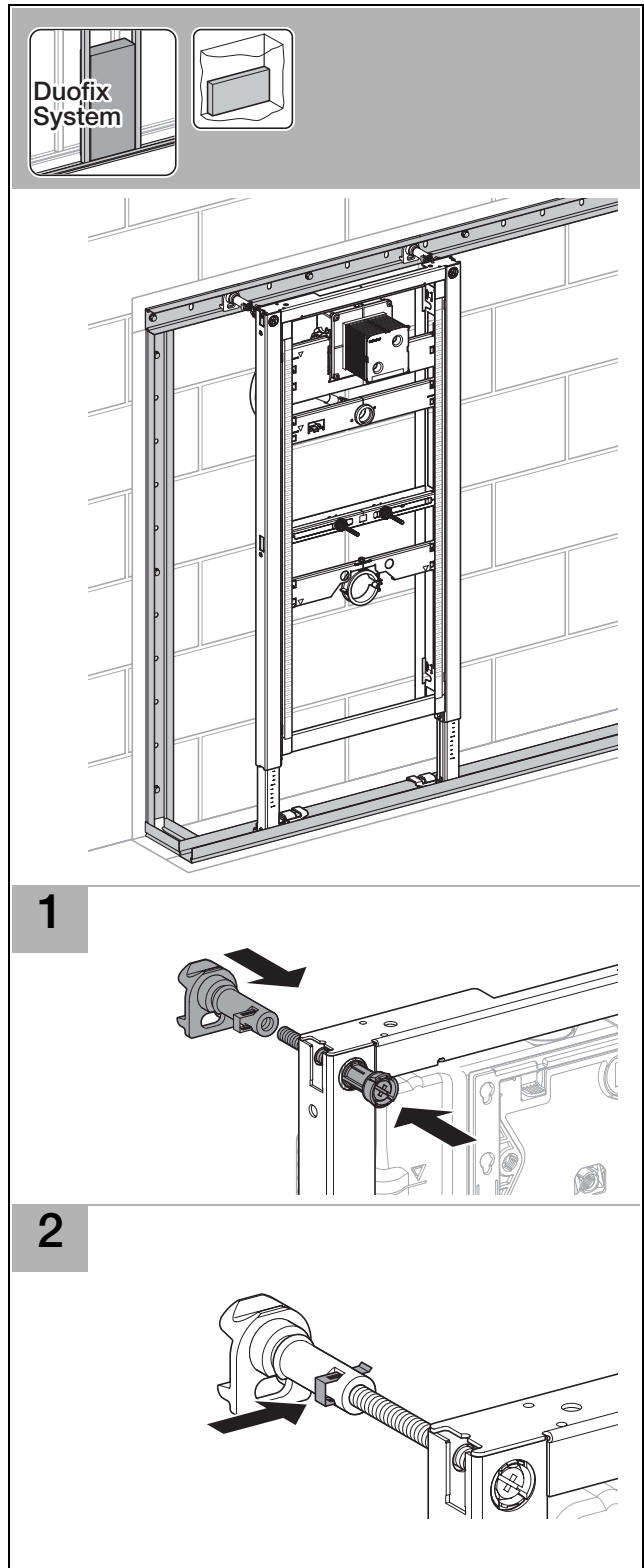
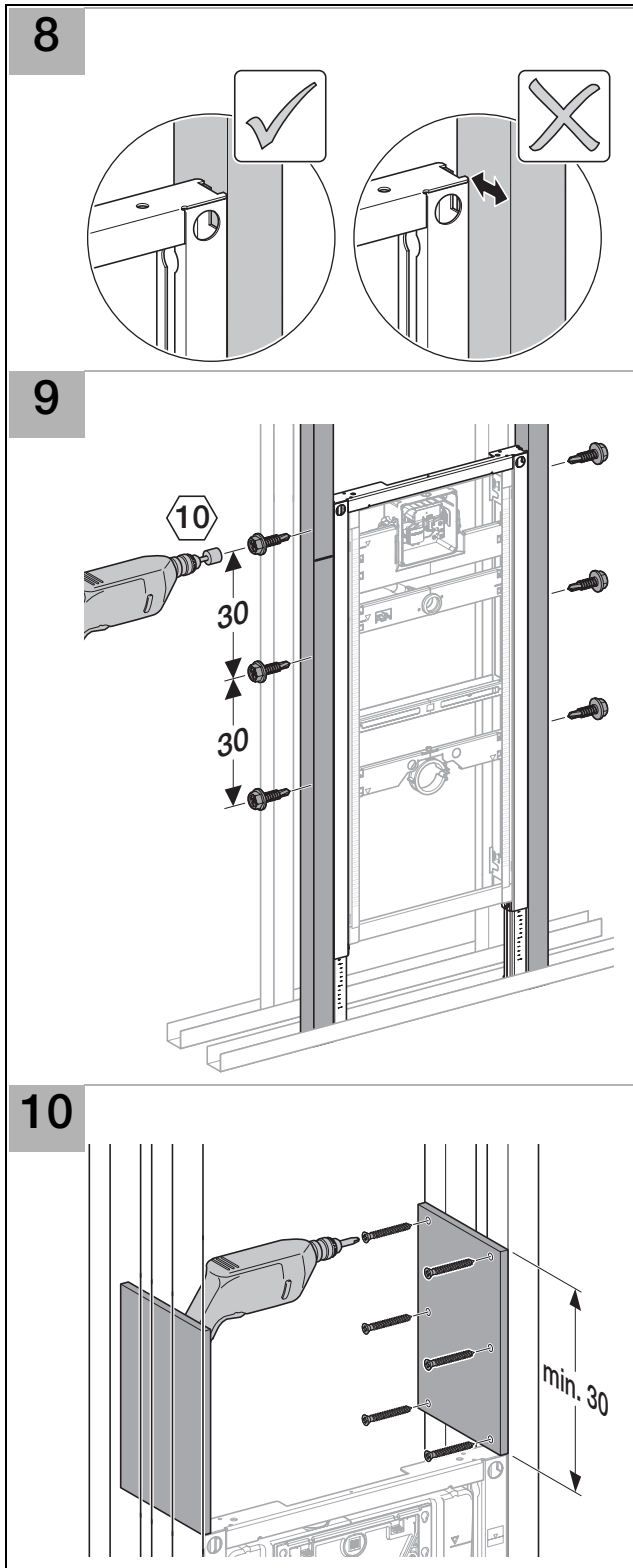



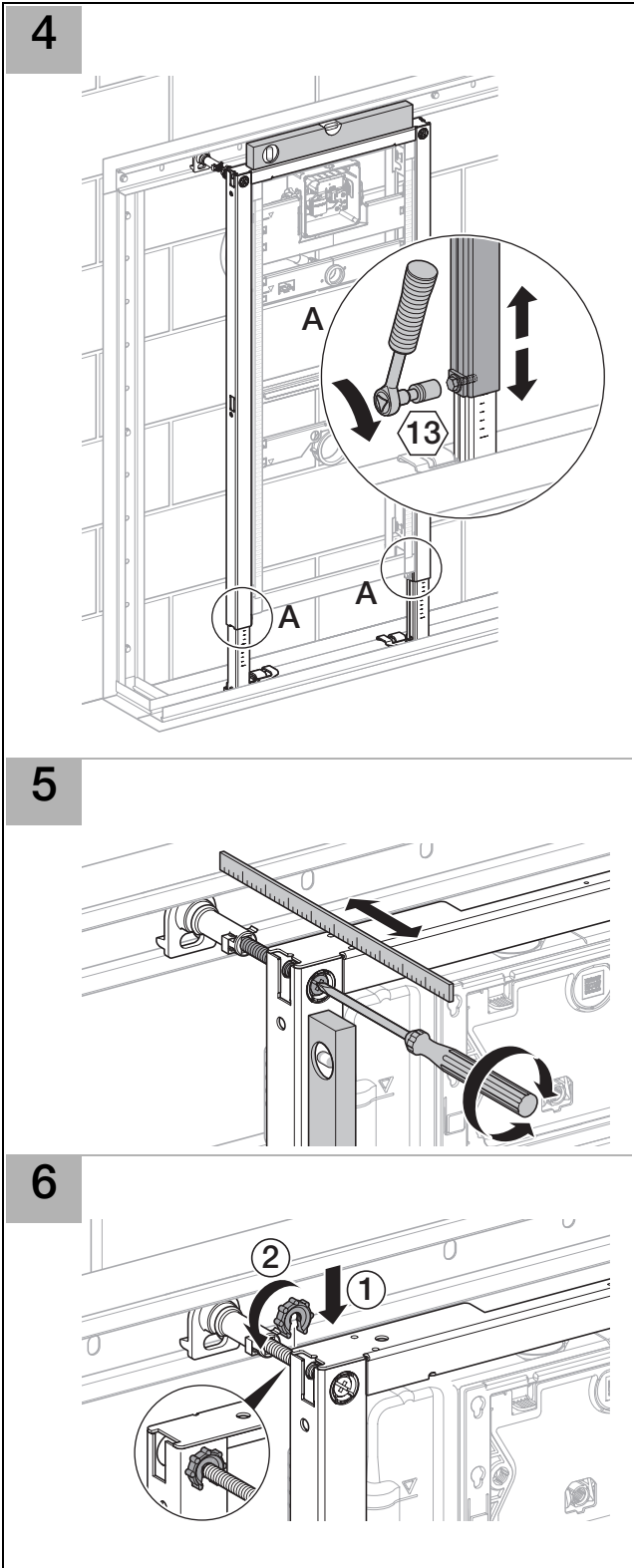
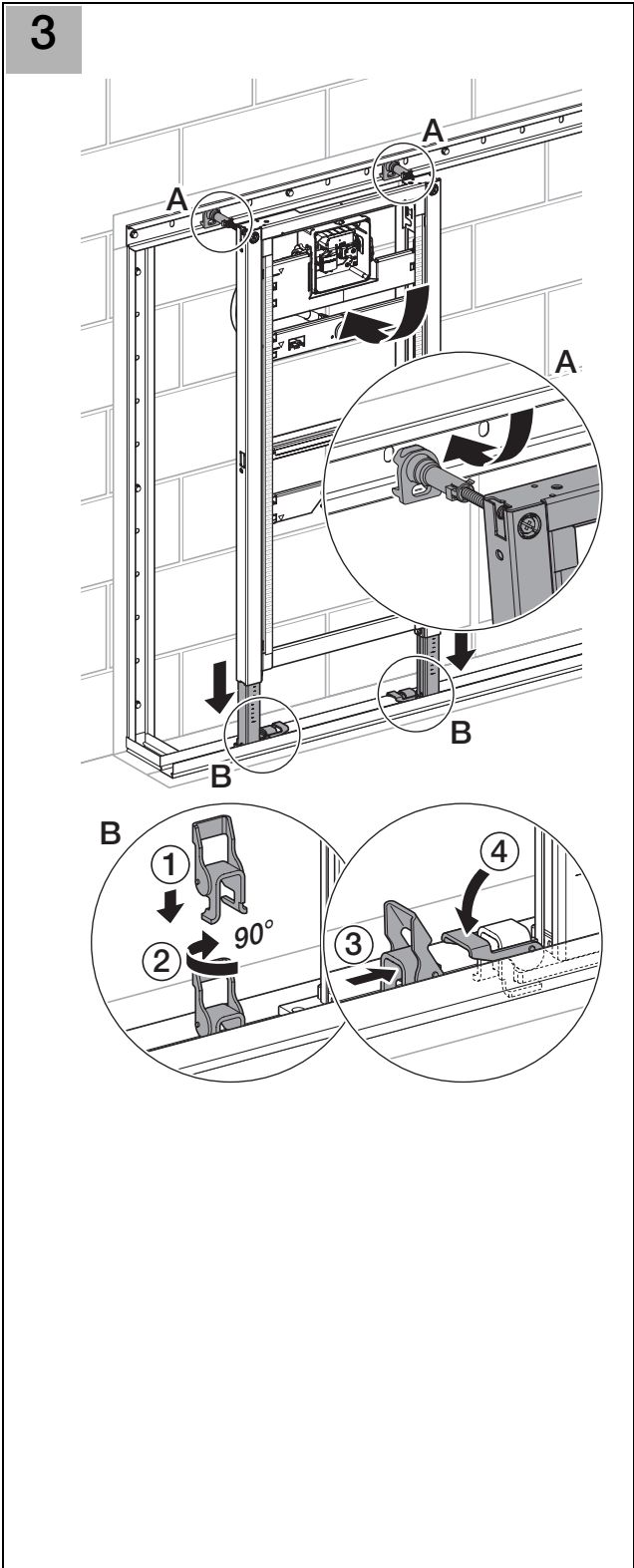

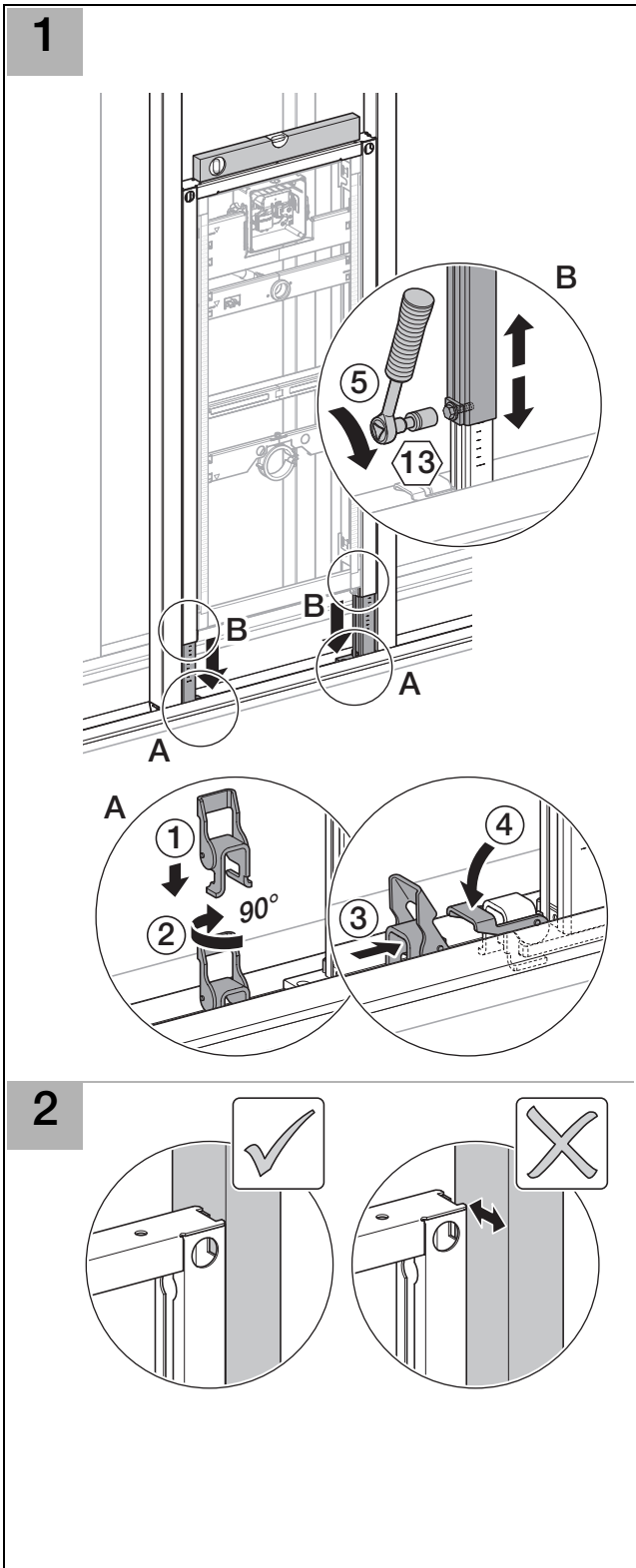
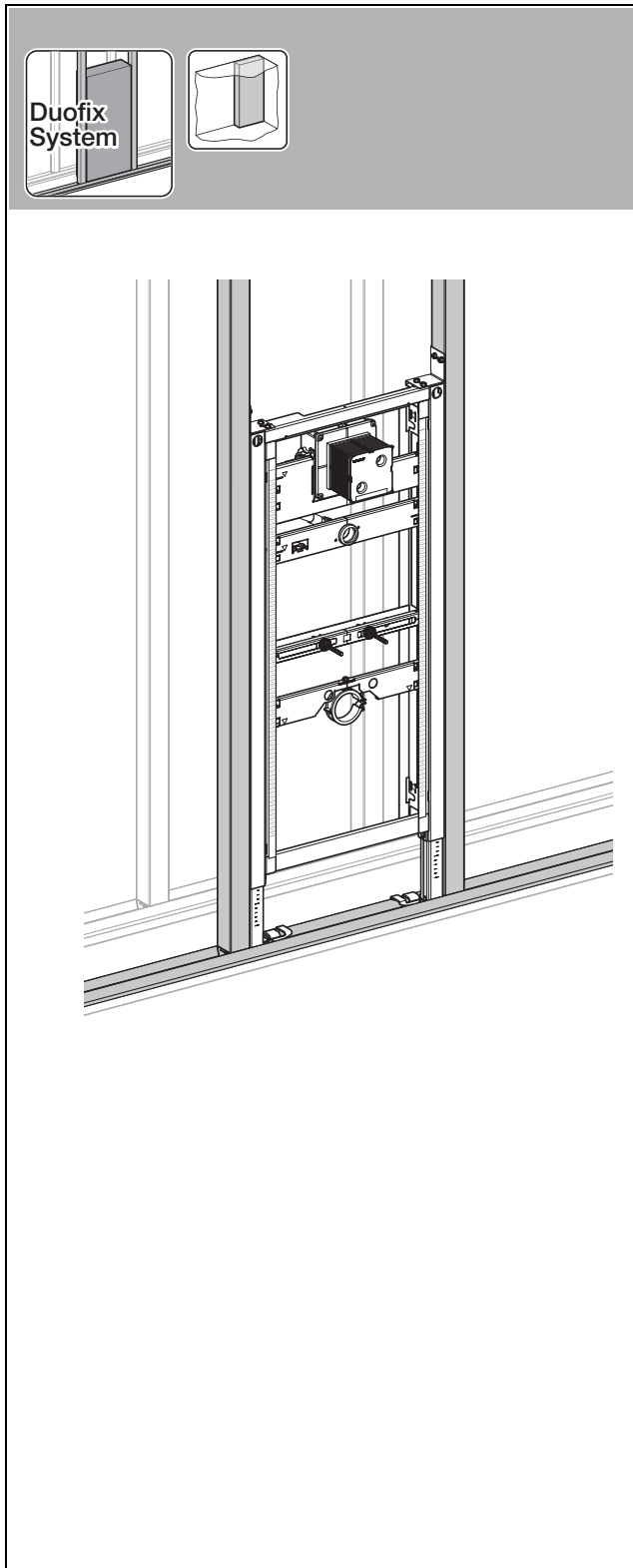

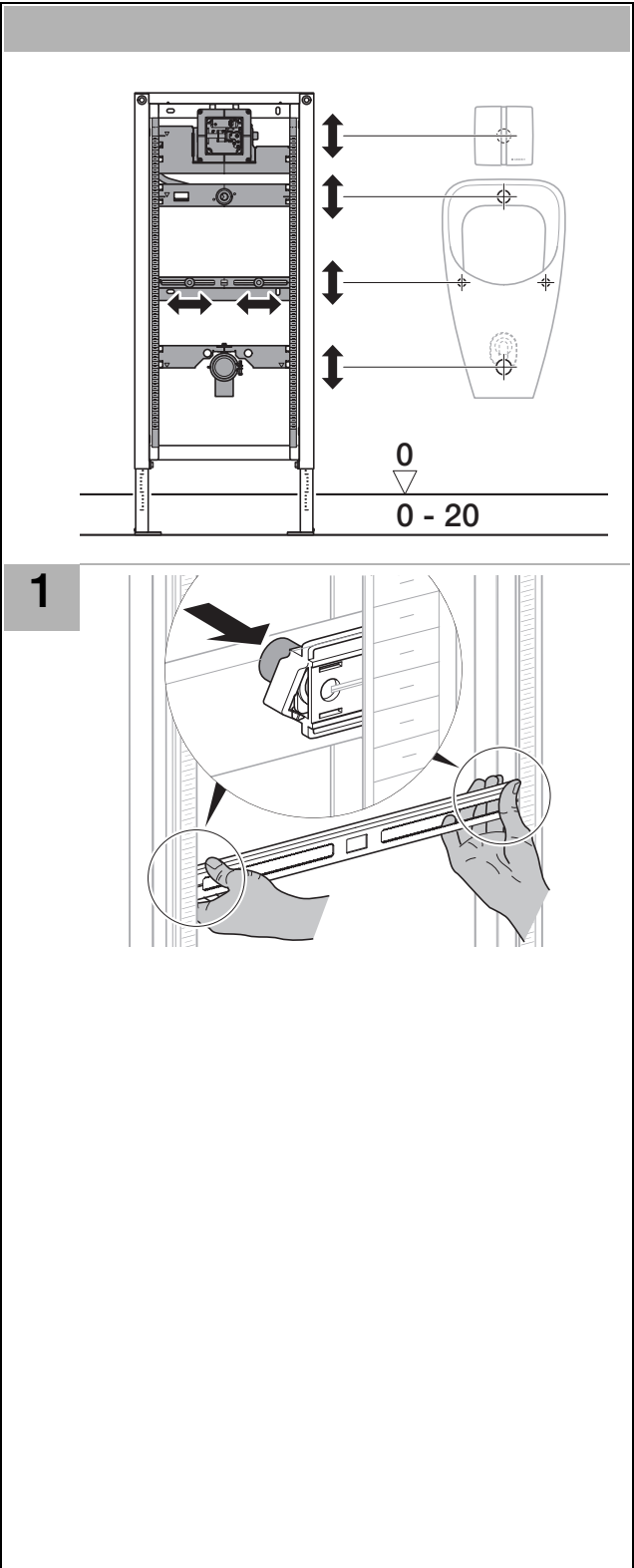
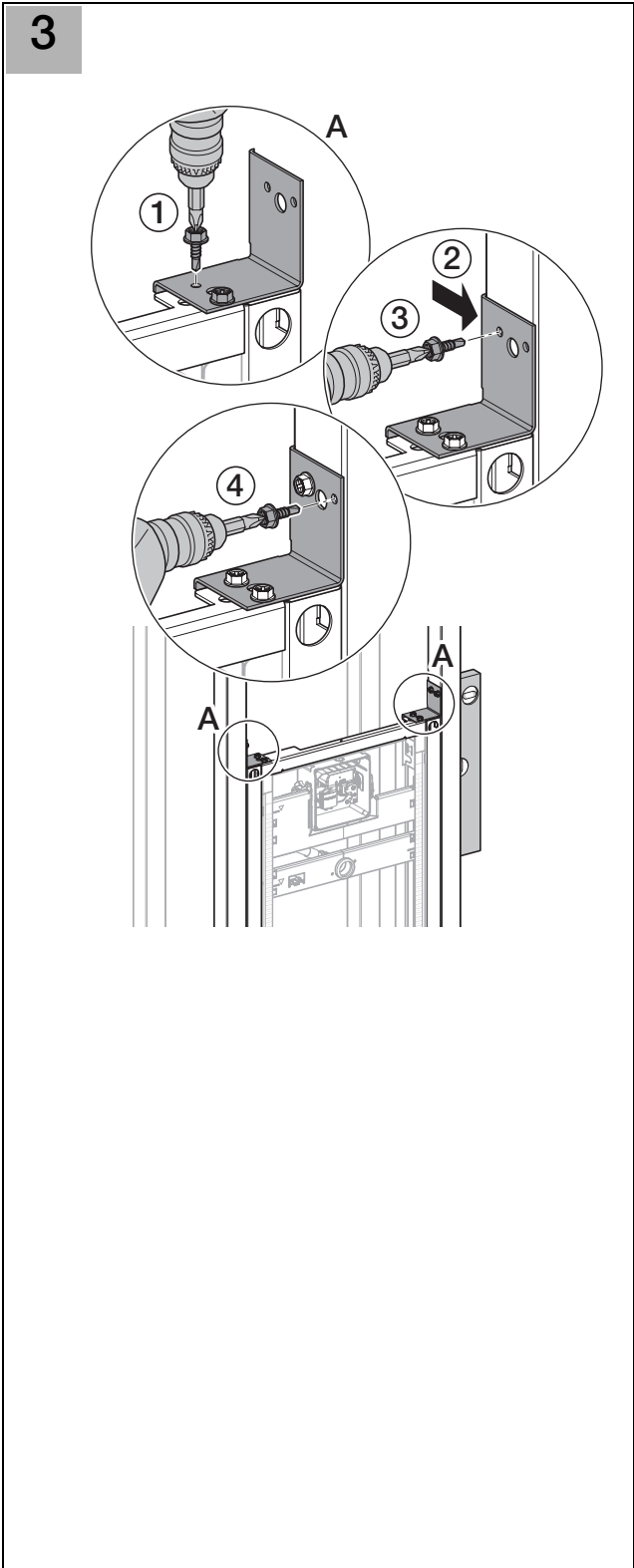

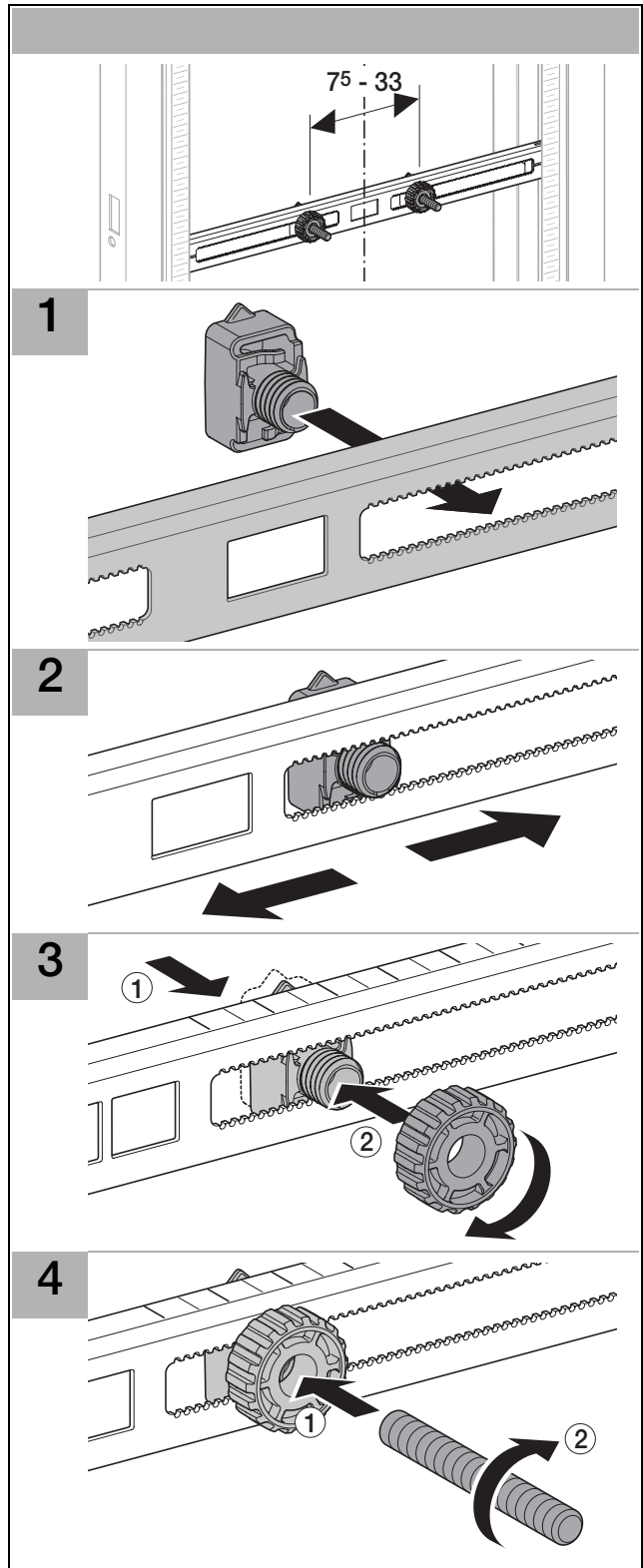
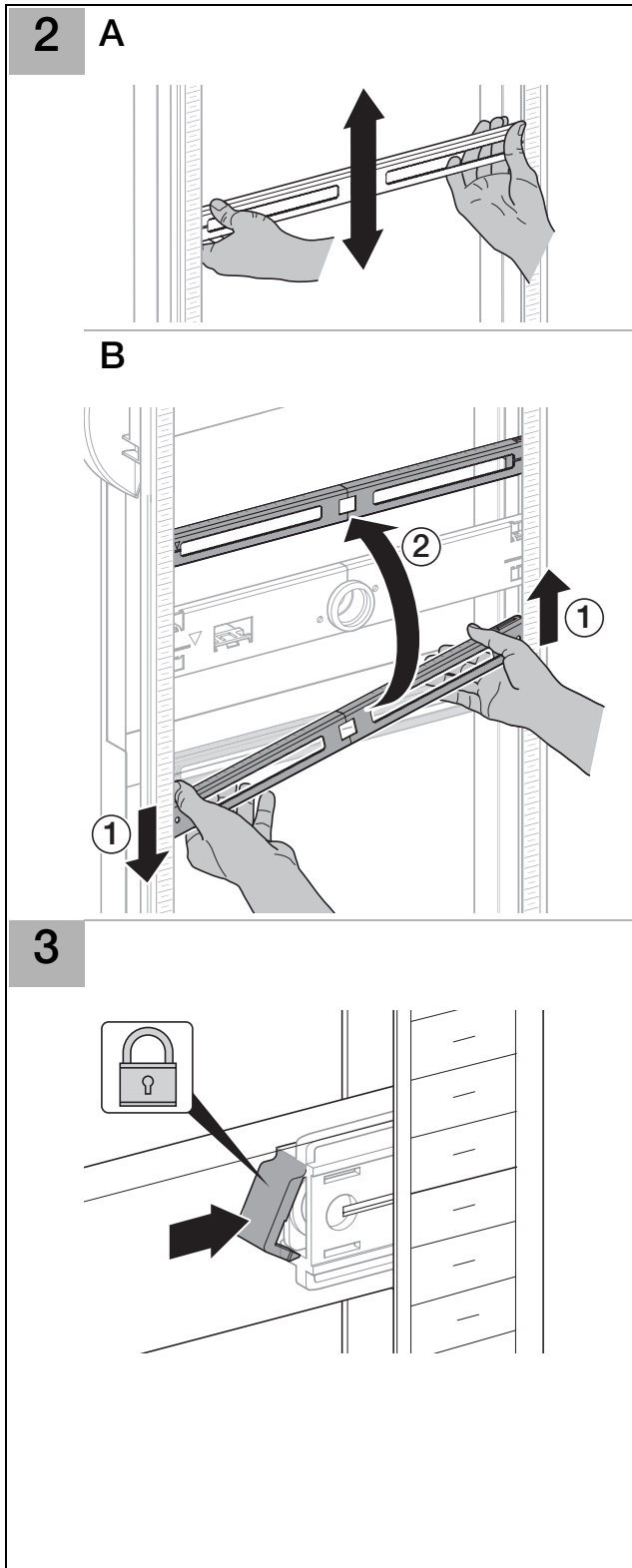

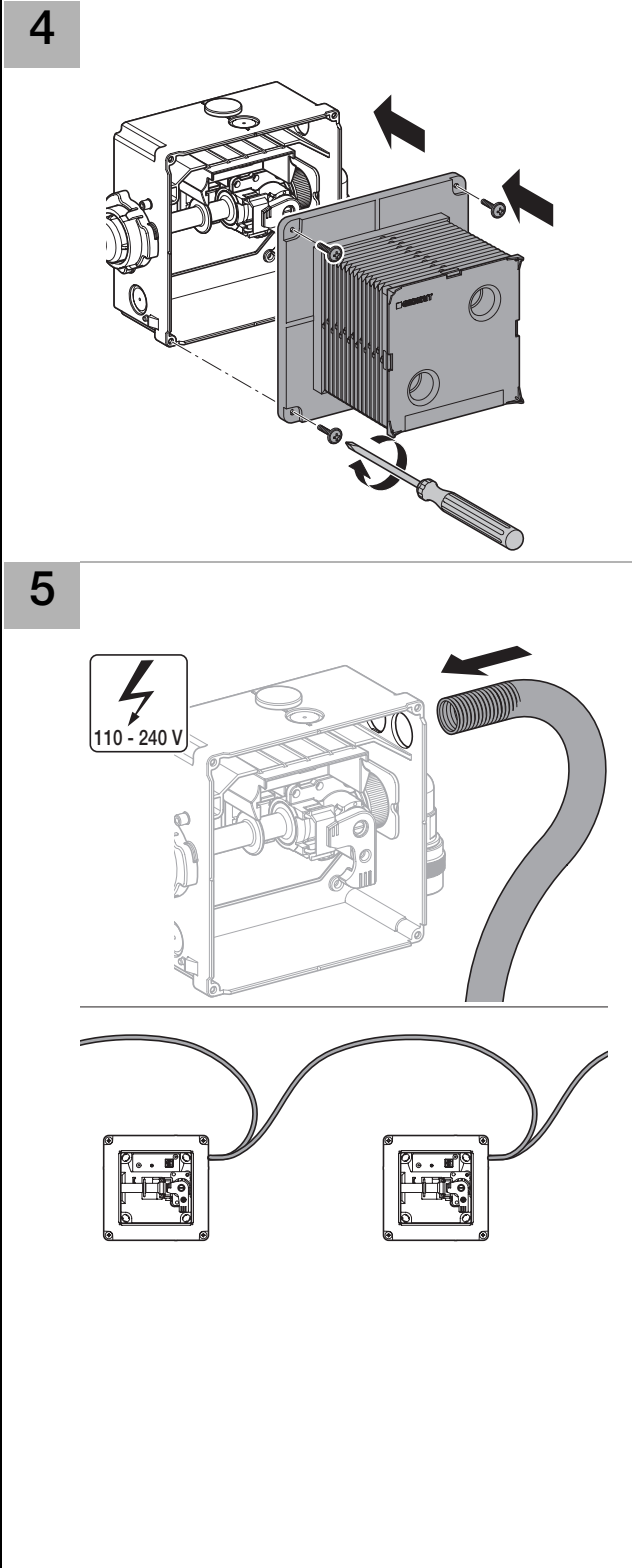
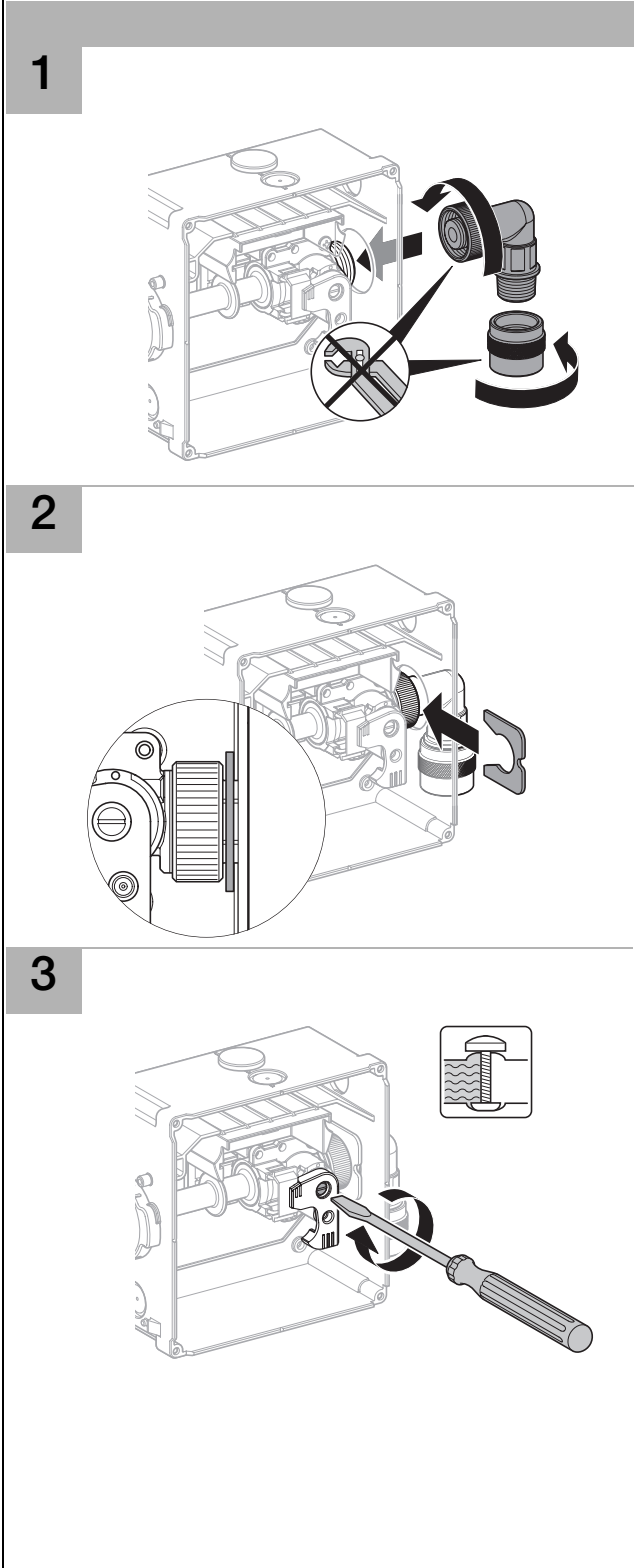

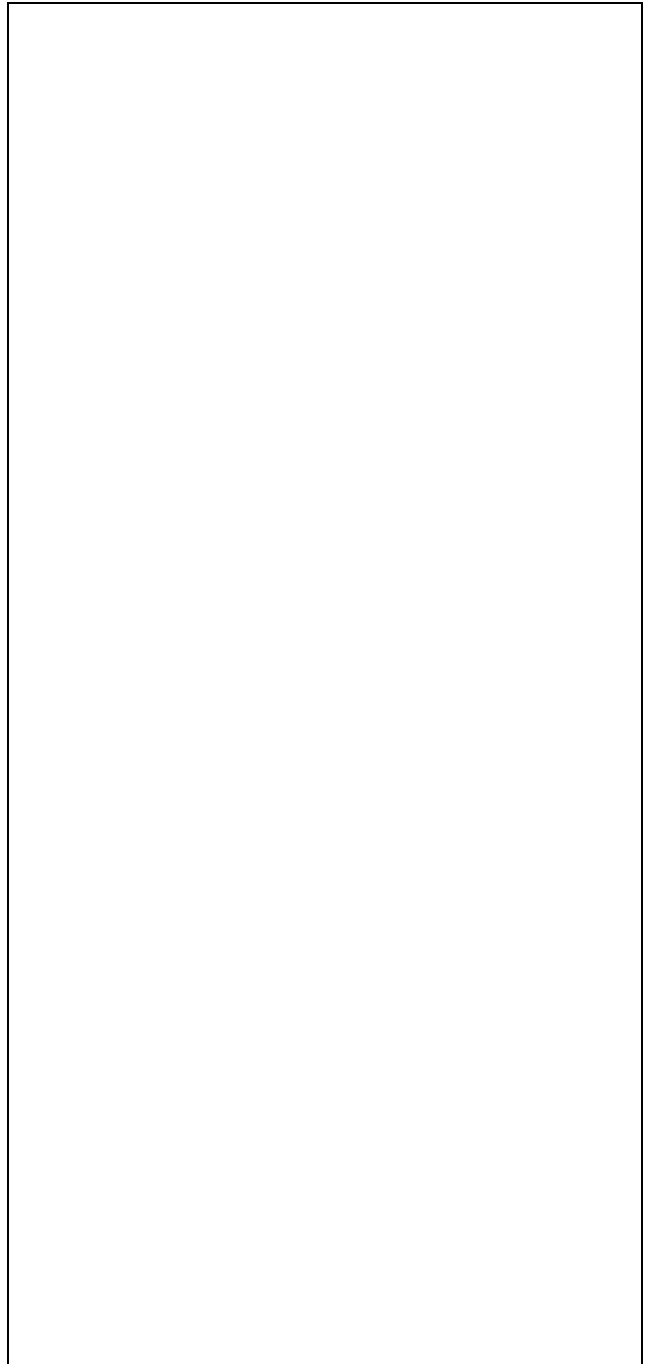
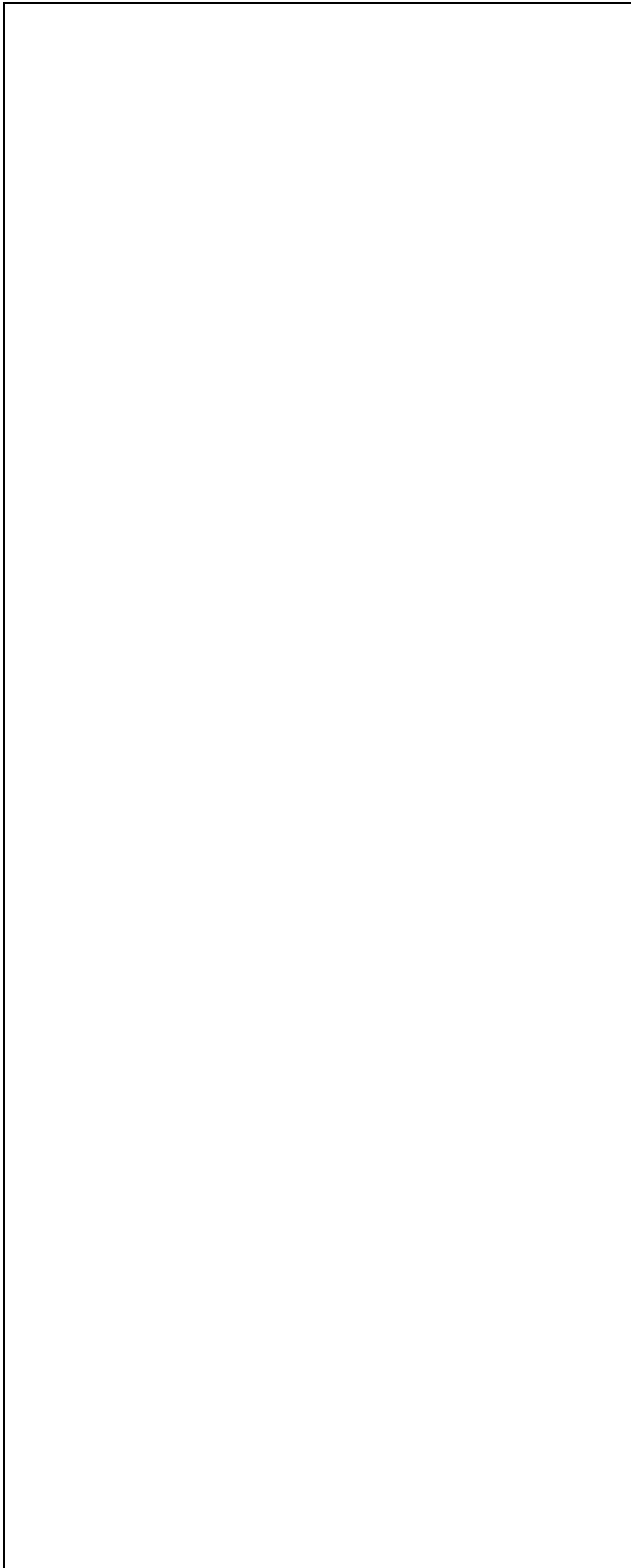

Geberit International AG  
Schachenstrasse 77  
CH-8645 Jona  
[www.geberit.com](http://www.geberit.com)  
[dokumentation@geberit.com](mailto:dokumentation@geberit.com)

D19932-001&BDC © 07-2008