

Installation

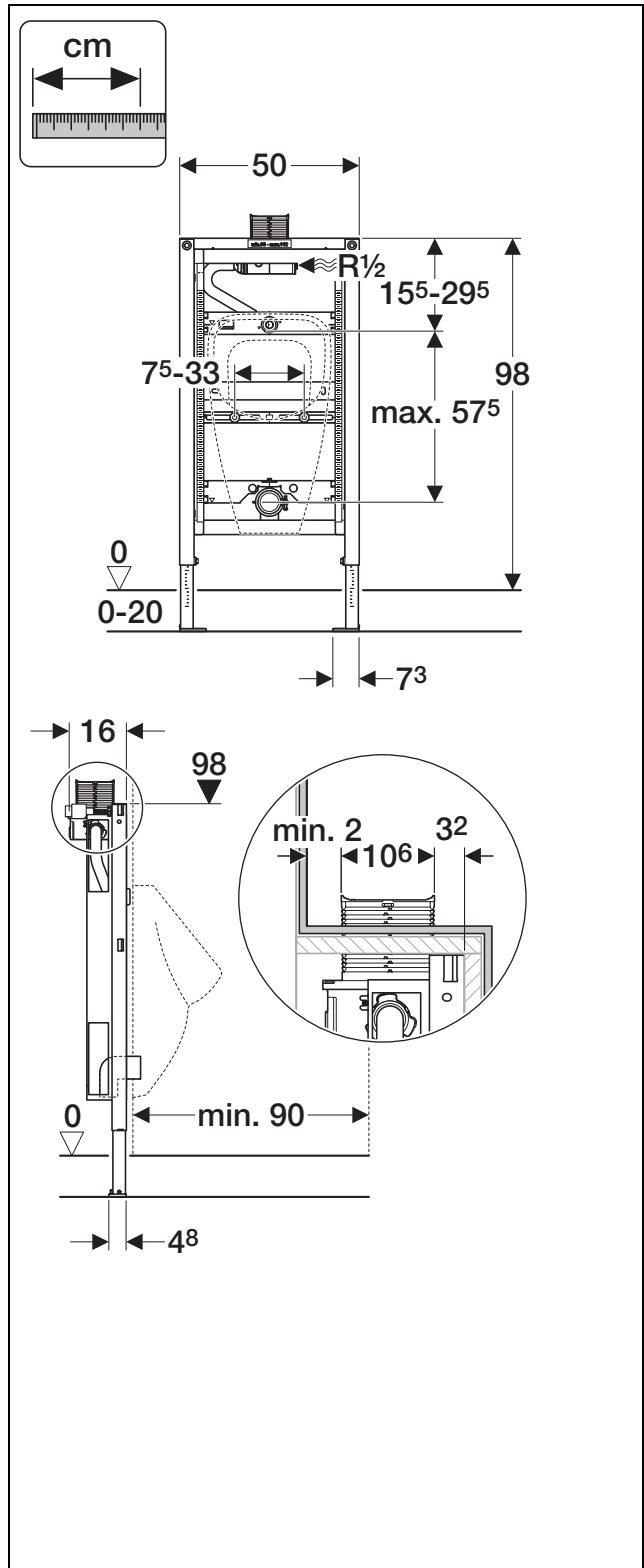

D23154-002&BDC © 10-2008

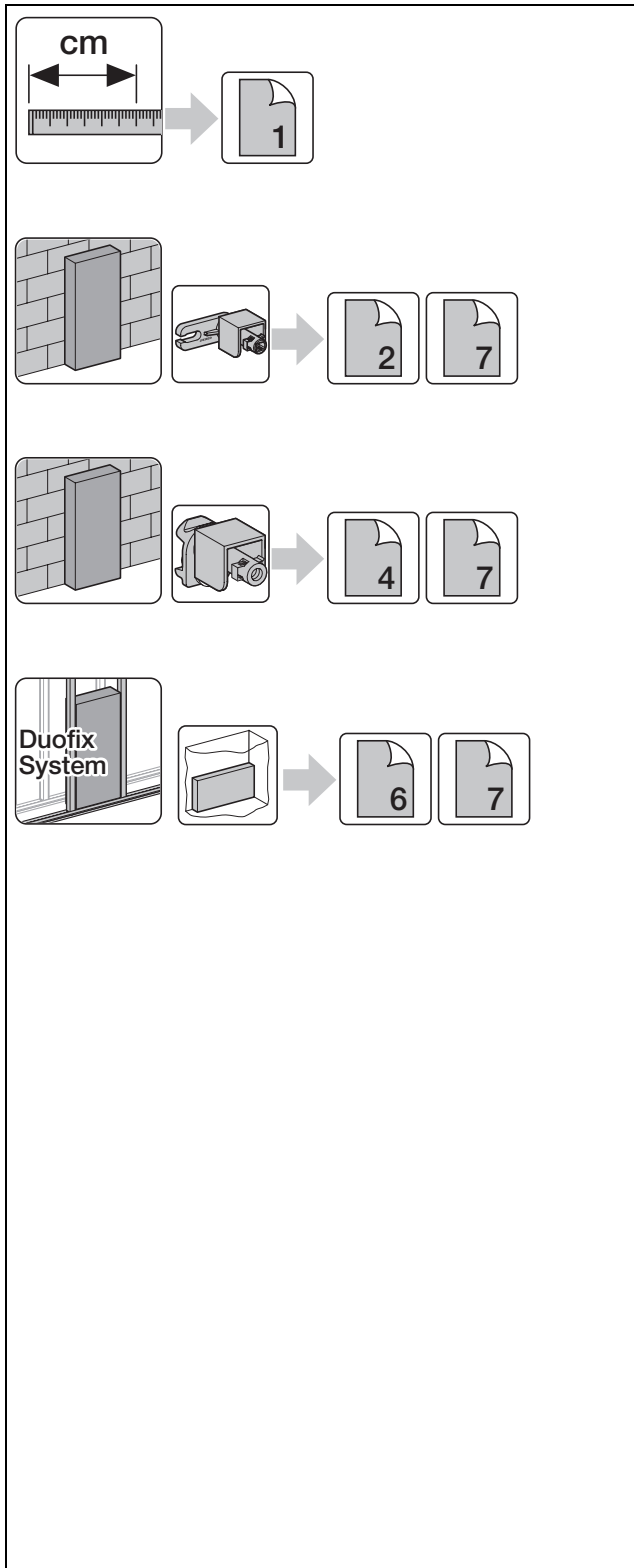

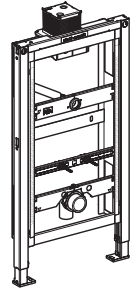
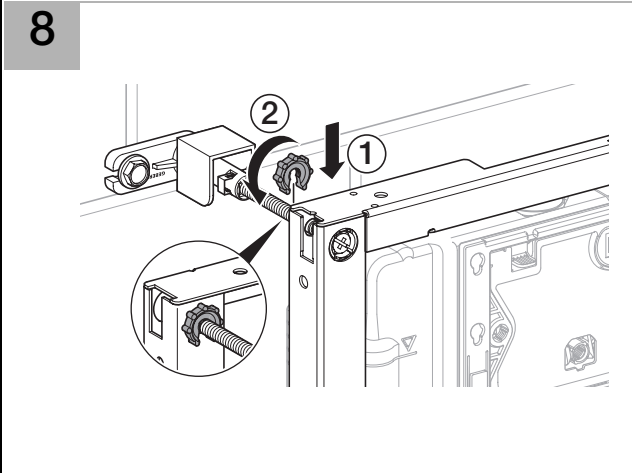
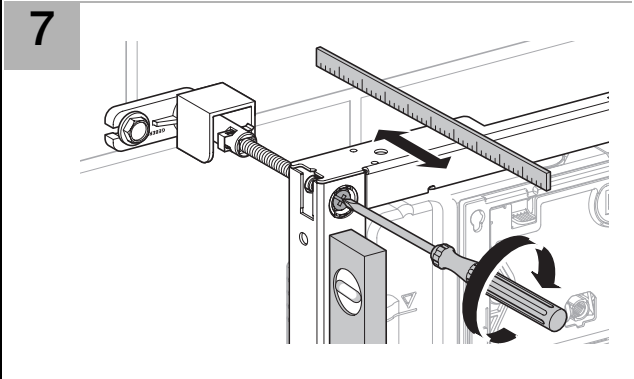
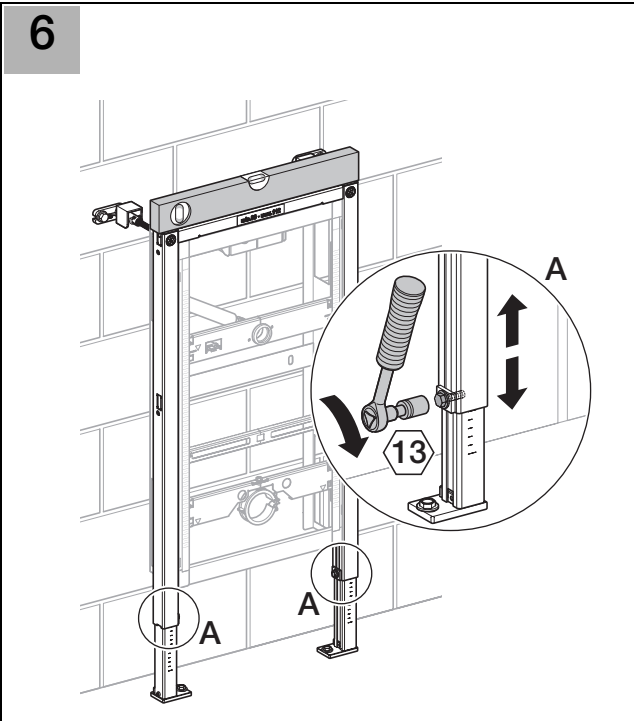
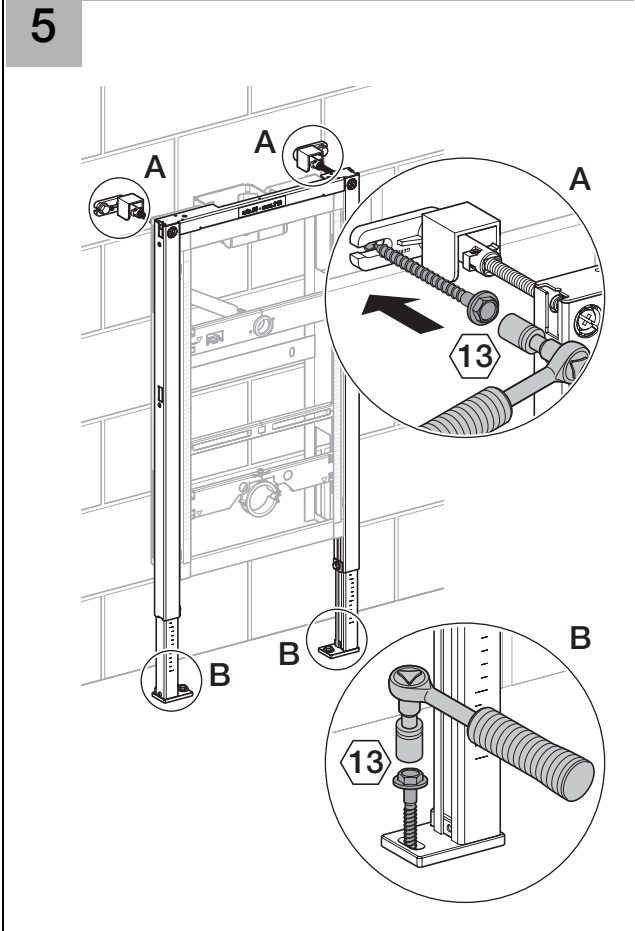
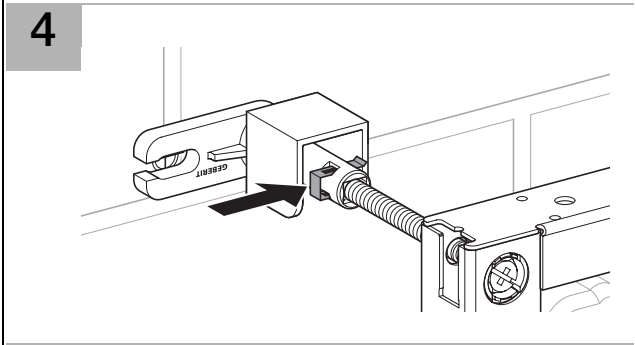
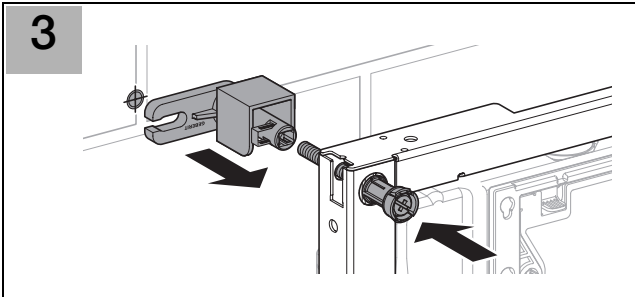
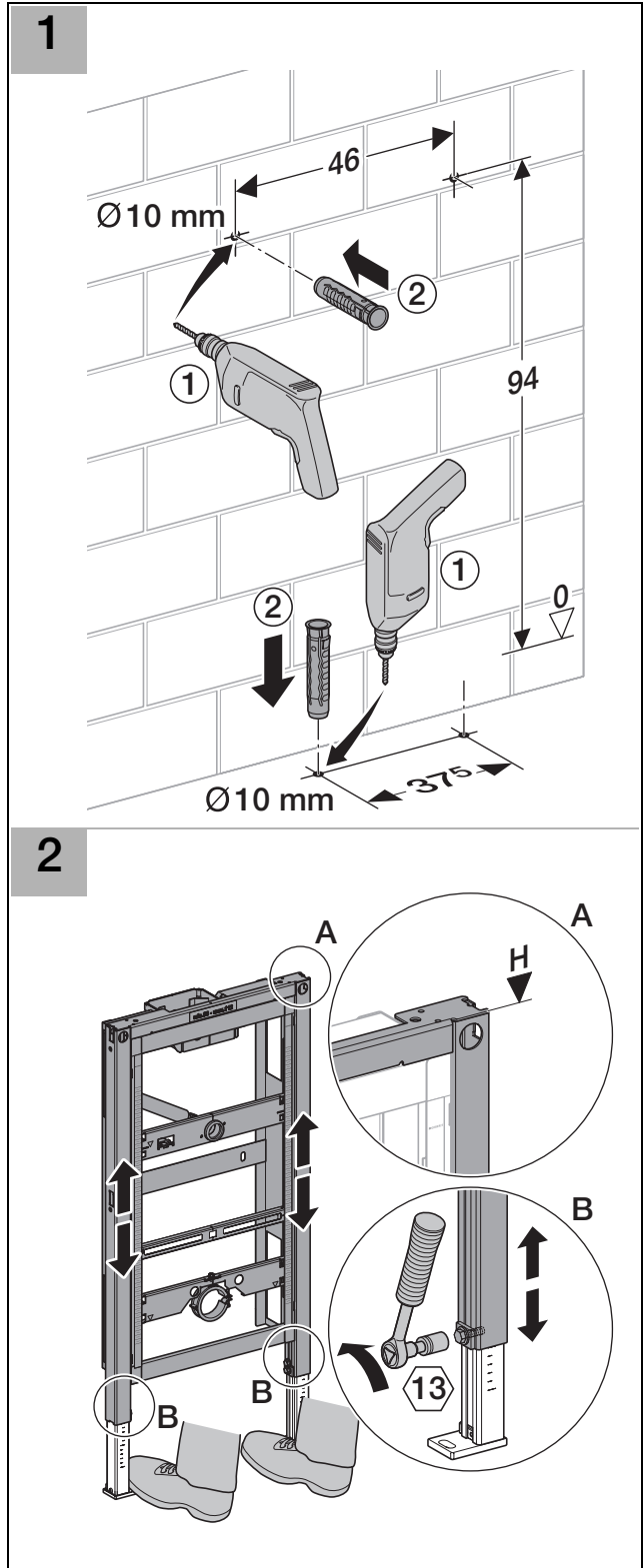
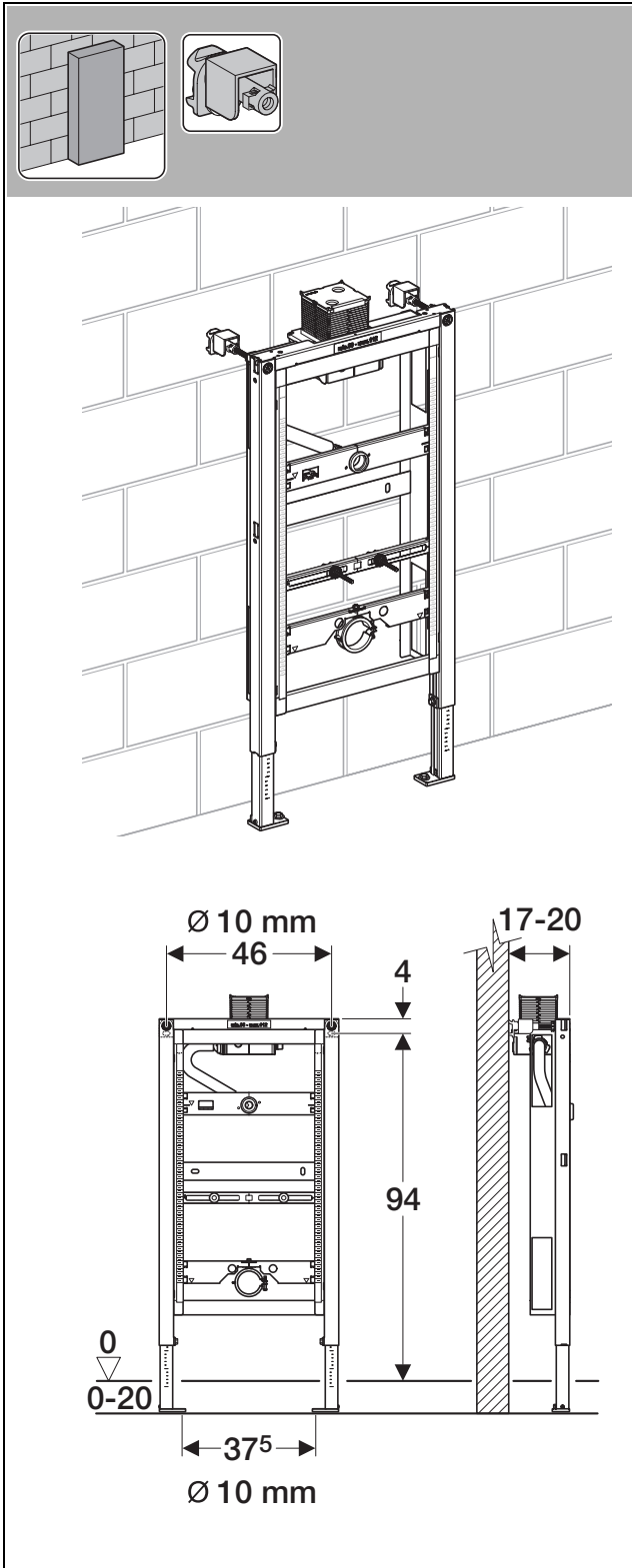

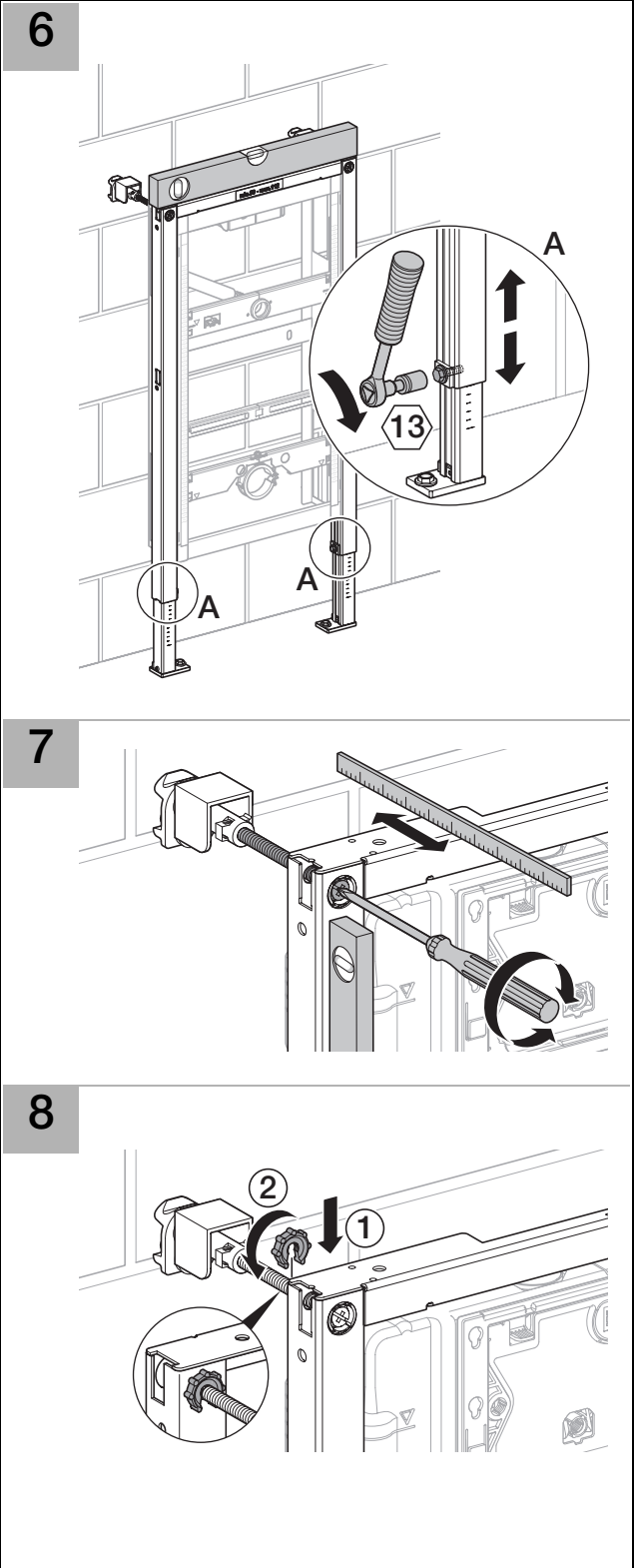
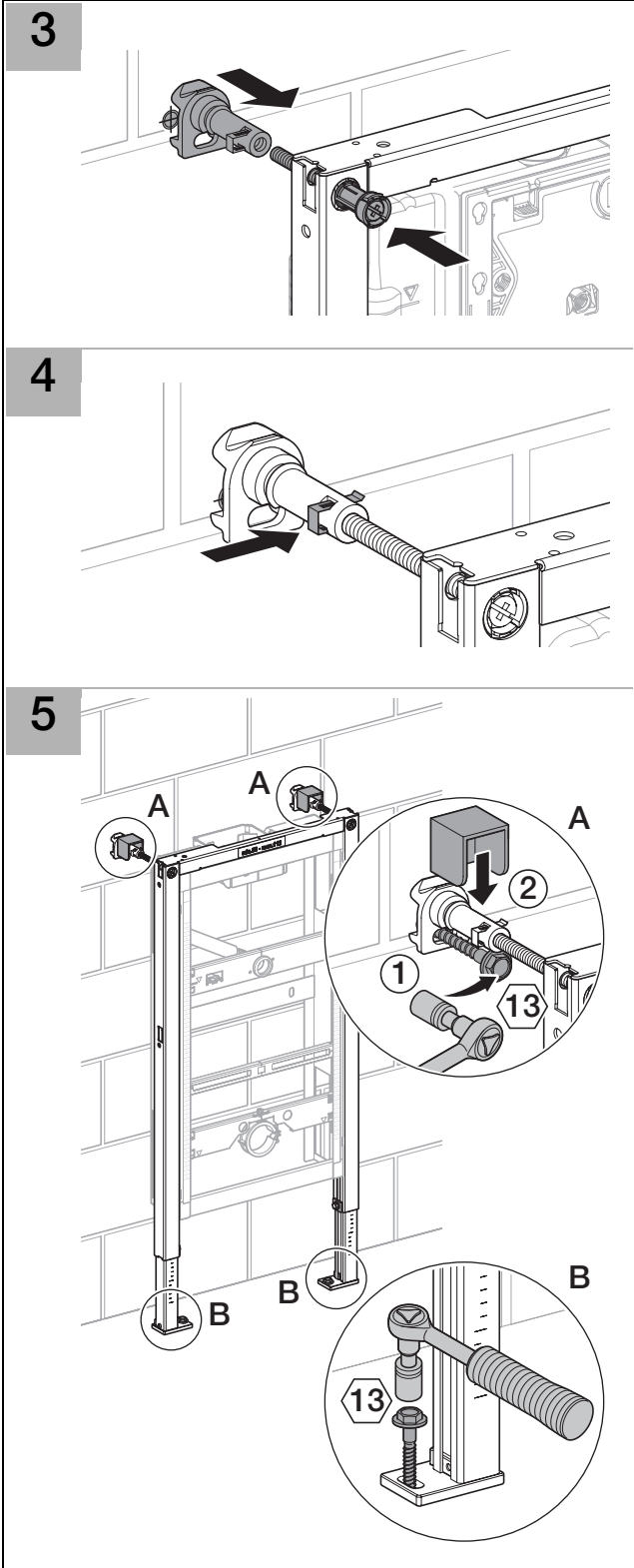

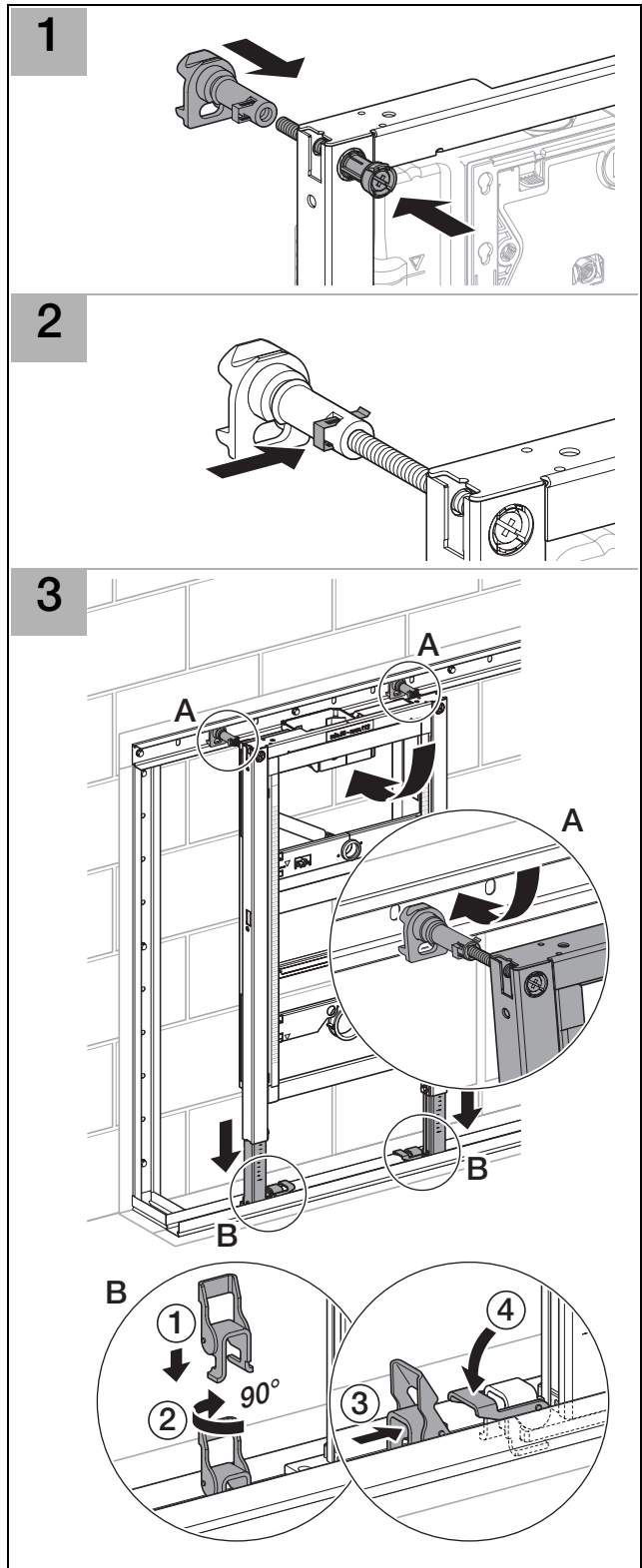
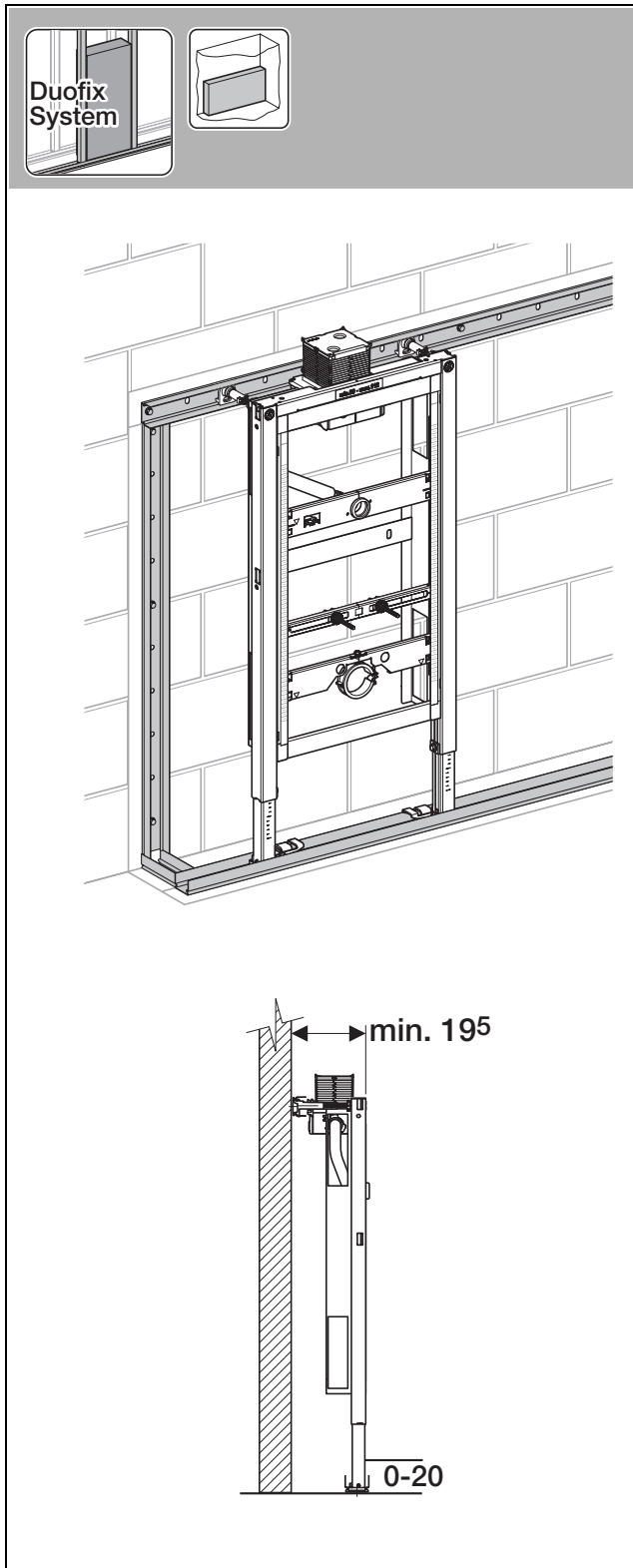

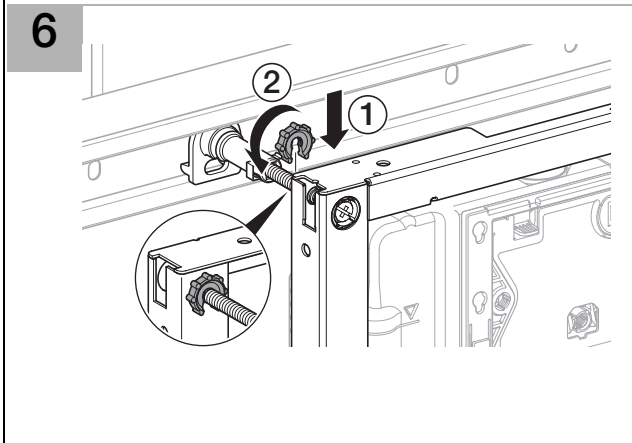
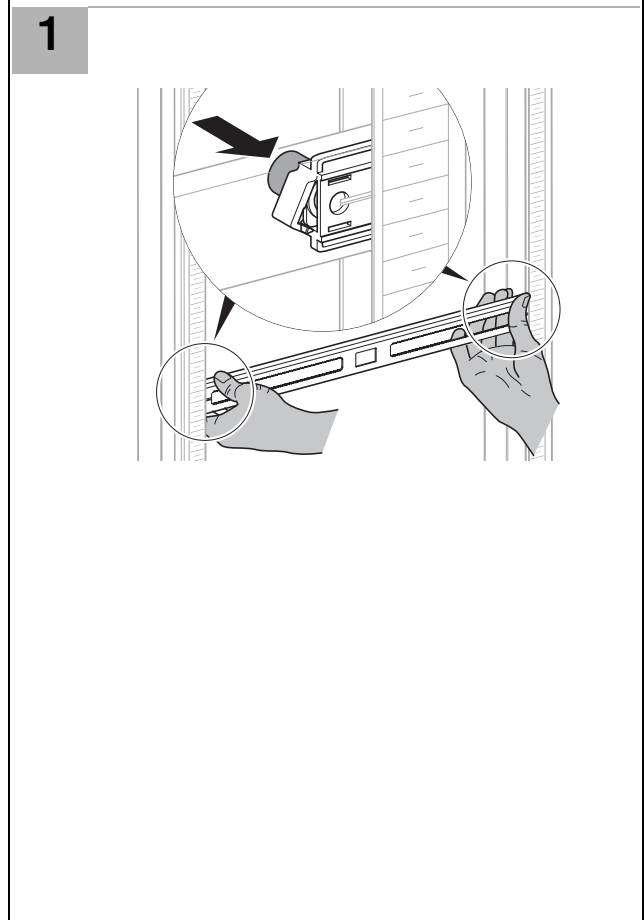
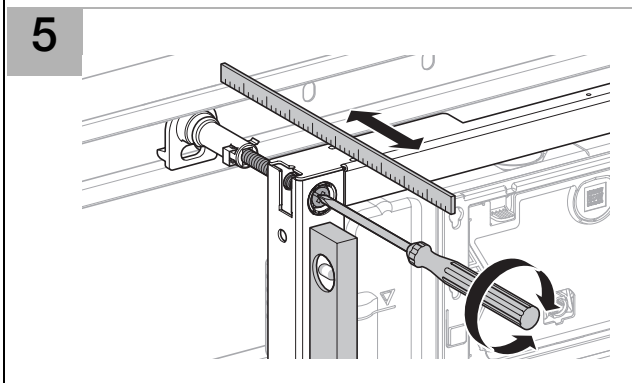
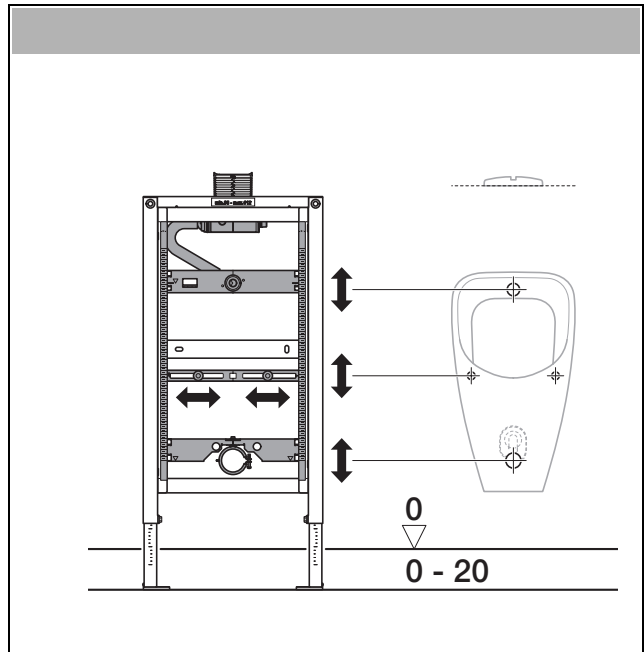
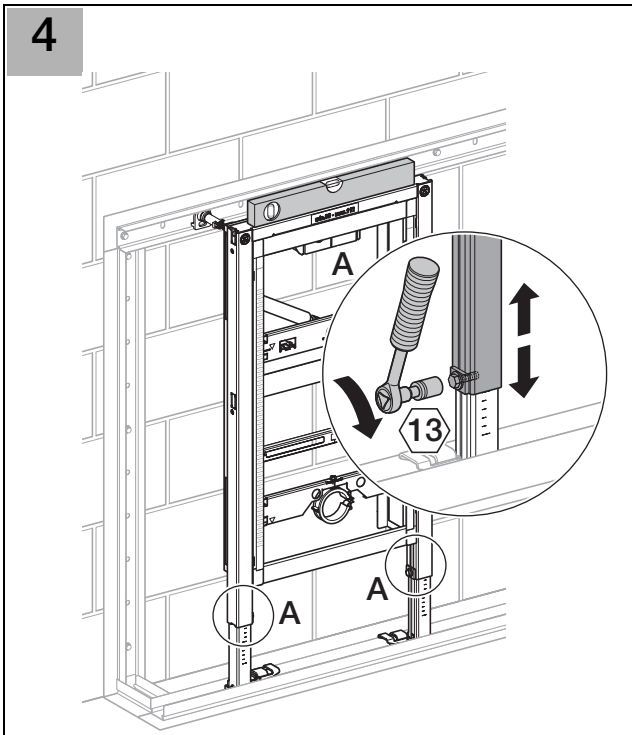

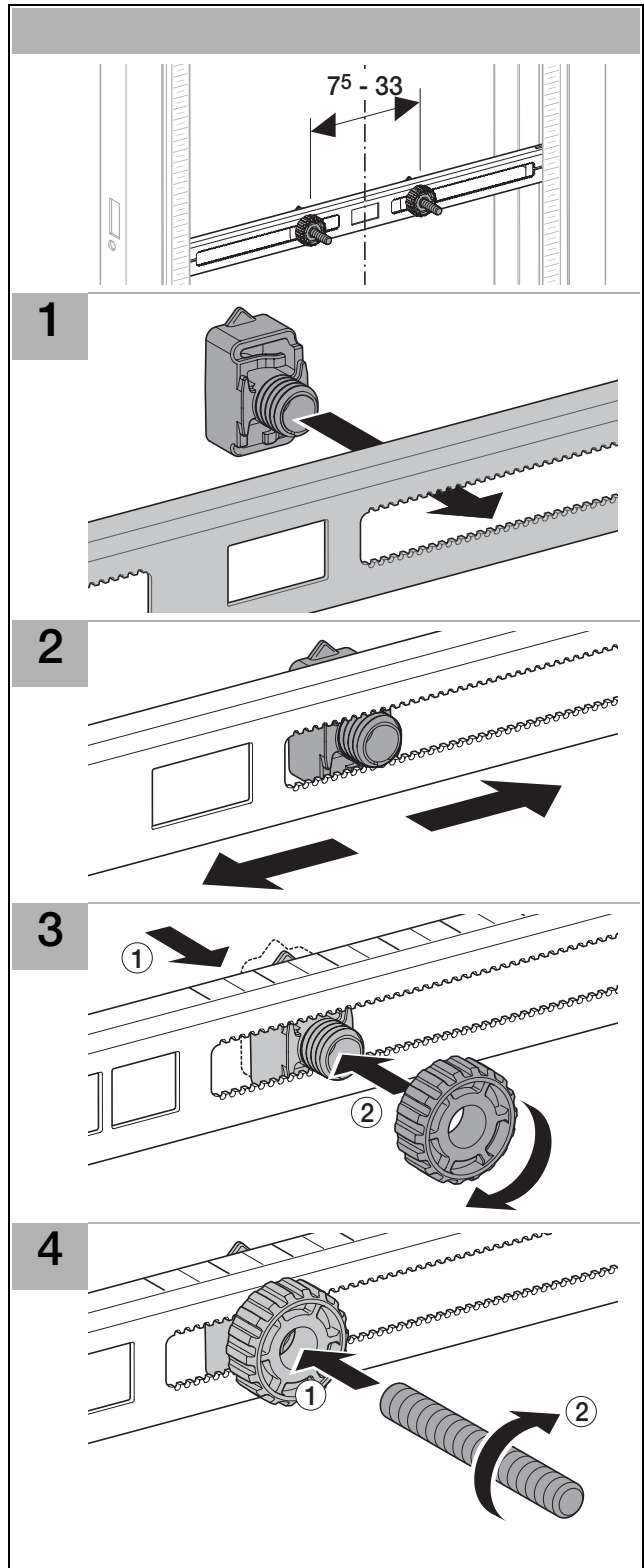
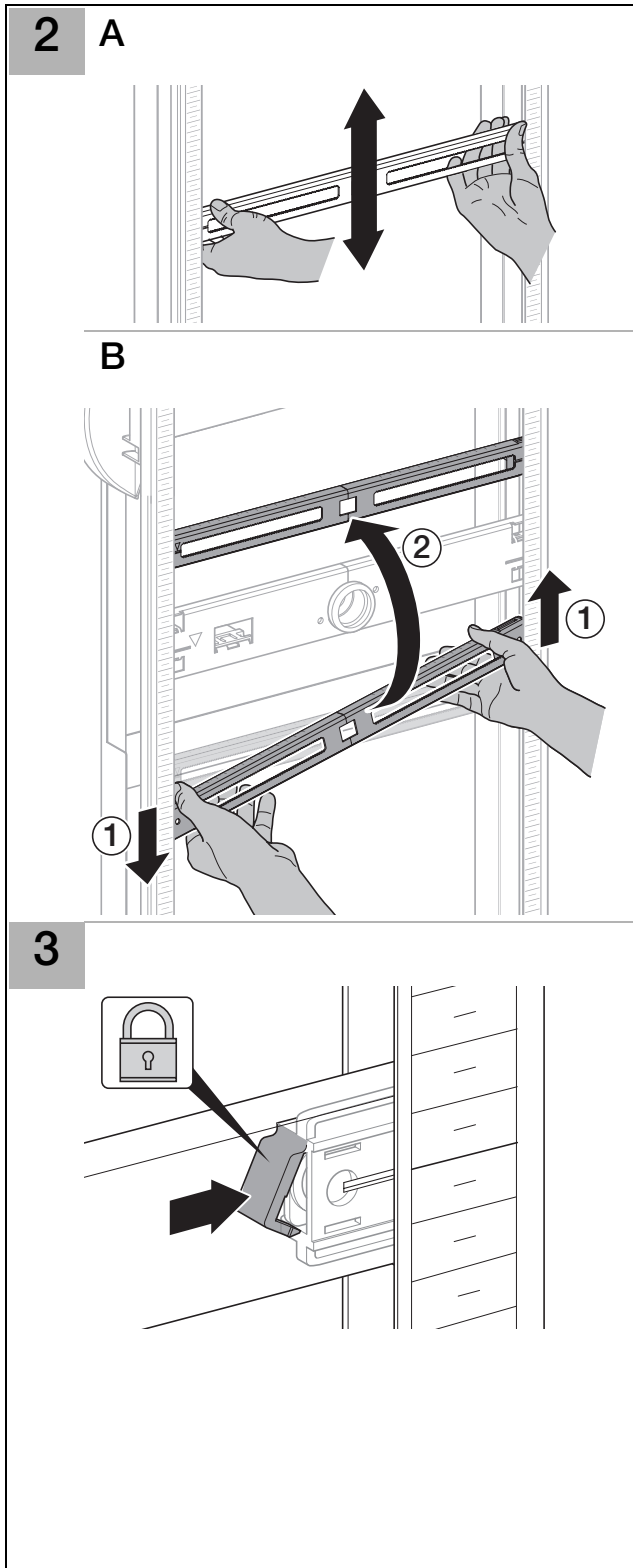

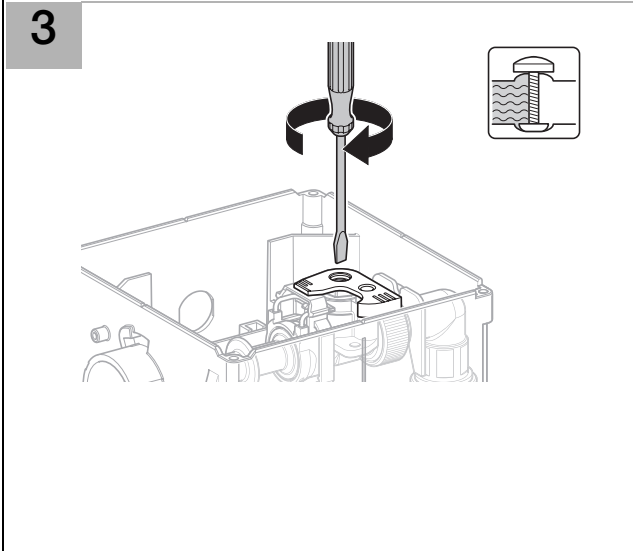
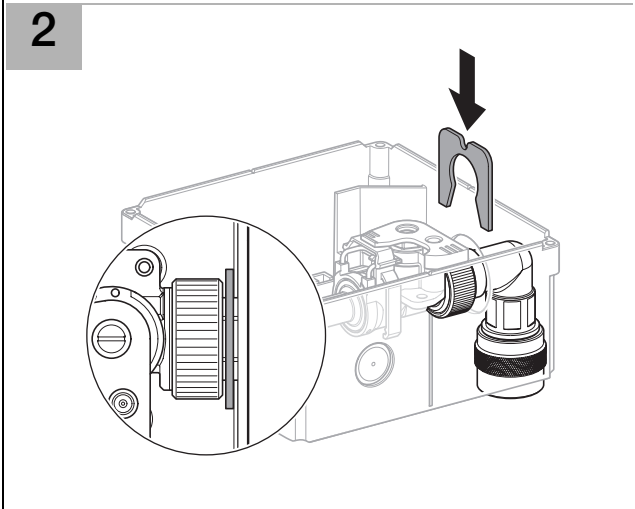
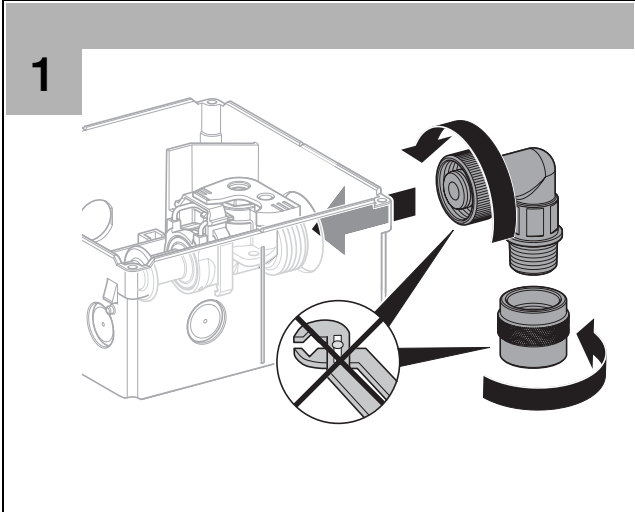

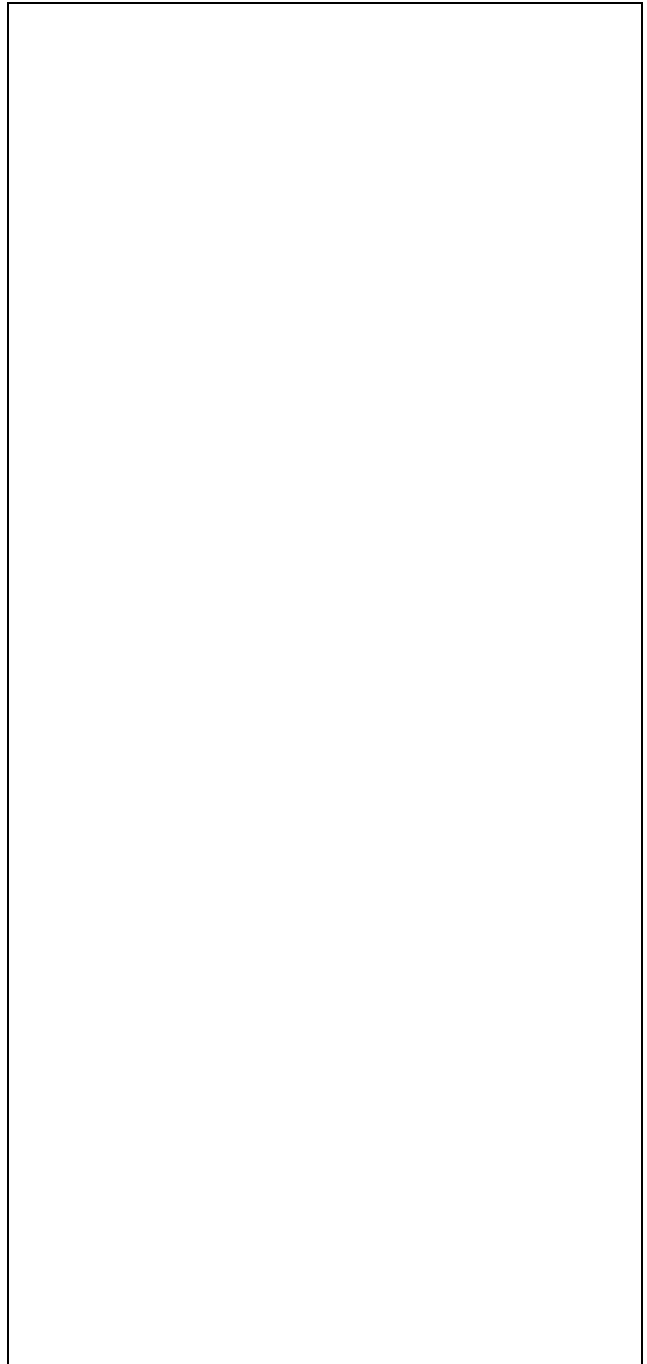
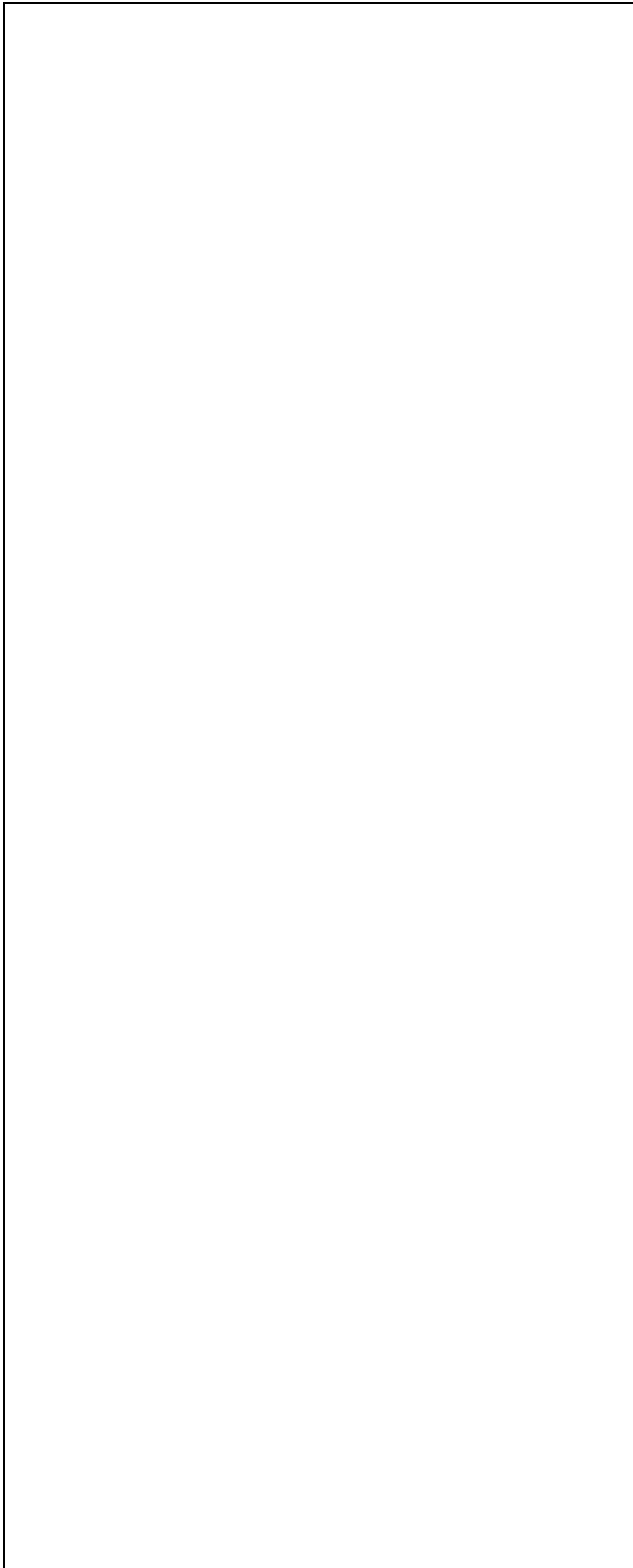

Geberit International AG
Schachenstrasse 77
CH-8645 Jona
www.geberit.com
dokumentation@geberit.com